

UCH-I Capture Ray™ condensate hood

◦ For heavy steam-producing equipment ◦ Capture Jet™ technology ◦ KSA aerosol separators ◦ UV-C Capture Ray™ technology ◦ Halton Skyline LED Lighting

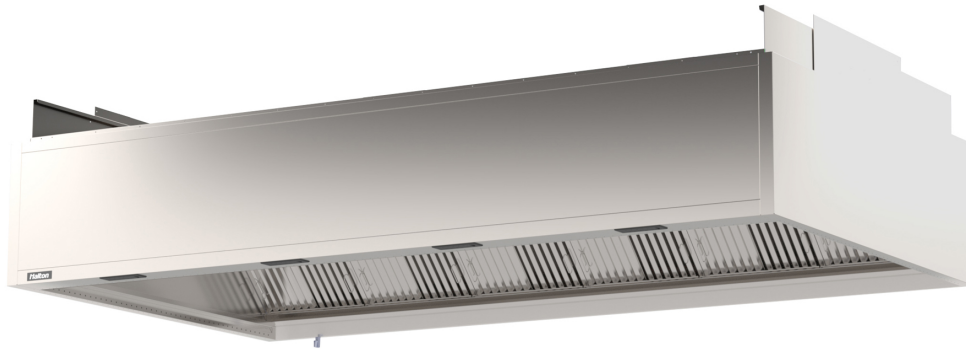

Product certification(s)



Components certification(s)



Main technologies and options



Anti drips design
Prevents the formation of condensation drips for a better hygiene



Capture Jet™ technology
Up to 40% reduction in exhaust airflow thanks to a better capture efficiency



KSA aerosol separators + MFA mesh filters
Up to efficient on 10 microns particles



UV-C Capture Ray™
Neutralises grease vapors and particles



UV On Demand (Option)
Saves up to one in two sets of UV-C lamps



Halton FireWatch
Detects a fire risk before it occurs (Combined with "On Demand" feature)



HCL Halton Skyline
Daylight similar LED Culinary Lighting and human centric



Halton Touch Screen
Simplified and intuitive LCD user interface



Halton Connect®
Cloud-based control platform with distant monitoring capabilities (1)



Option for decarbonized stainless steel
An ecological and sustainable choice

(1) The access to Halton Connect® web portal is included in the 1-year warranty period. After this period, it is subjected to one of the Halton Care service offer.

Recommended combinations



Further increase the energy savings and improve staff's comfort <-> Go for M.A.R.V.E.L. airflow and energy optimization technology



Establish restaurants in premium locations and increase profitability <-> Go for PolluStop pollution control units and reassure neighborhood



Don't risk bankrupt or business downtimes because of a cooking fire <-> Go for FSS Fire Suppression System pre-installed from factory



Optimize the ductwork cleaning costs and further improve your safety <-> Go for KGS grease deposition level monitoring system for ductwork

Description and main technologies



- The **Capture Jet™ technology** allows for up to a 40% reduction in exhaust airflow rates.
- The combination with M.A.R.V.E.L. airflow and energy optimization technology allows for reducing the exhaust volumes by up to an additional 44% on top of that of the **Capture Jet™** resulting in up to a 64% total reduction.
- The energy savings on heating/cooling the makeup air then become massive (less air out, less air in!).
- The reduction of the draft risk and noise levels improves the working conditions for the staff.

Applications

Halton Capture Jet™ hoods and ventilated ceilings are all suitable for [LEED](#) (1), [BREEAM](#) (2), [DGNB](#) (3), [RE2020](#) (4) etc. projects, particularly when combined with M.A.R.V.E.L. airflow and energy optimization technology. Specially designed for heavy steam producing equipment, they are particularly suitable to central kitchens, asian steam cooking and food industry.

In addition to the **Capture Jets**, UCH-I hoods are also equipped with the **Capture Ray™** technology.

The **Capture Ray™** technology is more typically used for commercial kitchens whose ducts are difficult to access for cleaning, as well as for kitchens located in classified buildings with strong fire safety requirements or with close proximity with the neighborhood.

Description

The **Capture Jet™** technology enables significant reductions in airflow rates leading to savings on construction costs, mainly due to the reduced size of ducts and HVAC equipment. It typically pays for itself upon the startup of the kitchen or within few months. The energy savings it generates then directly contribute to an increase in profitability, while the staff benefits from improved working conditions.

The **Capture Ray™** technology neutralizes the small grease particles, the grease vapors and a portion of the VOCs that can't be removed by any primary mechanical filtration. It truly represents a unique ensemble of benefits, from savings on cleaning costs to optimal hygiene and fire safety levels, through to lower kitchens' environmental impact on the neighborhood.

UCH hoods are also designed to evacuate the condensation drips that may form inside their containment volume when used with heavy steam-producing equipment. The hoods are equipped with a gutter system installed on all four sides of the containment volume. This system collects water drips flowing down the sides and the hood's ceiling, whose diamond-point shape facilitates their flow. These provisions greatly improve hygiene by limiting the risk of condensation drips falling on the cooking appliance.

Considerable energy savings

Improved safety, maintenance savings and respect for the neighborhood

- Designed to channel excess condensation on hoods' interior surfaces to a perimeter gutter system to greatly improve hygiene.
- Two mechanical filtration stages. **KSA** cyclonic aerosol separators constructed of stainless steel in compliance with EN 16282-6. They are up to 95% efficient on 10 microns particles or larger. Also certified UL 1046, NSF, and LPS 1263. **MFA** Mesh filters as second filtration level to bring the total efficiency to up to 94% on 5 microns particles.
- **KSA** aerosol separators - together with **MFA** filters - only require the **Capture Ray™** neutralization technology to be used for medium to small grease particles, grease vapors, and VOCs.
- The **Capture Ray™** technology keeps the exhaust plenums and ductwork virtually free of grease deposits. The ductwork cleaning operations are cut down to the minimum legal frequency (if applicable) or to the strict minimum, leading to important savings.
- Hygiene and fire safety levels of the extract circuit are moreover kept at an optimum level.
- The **Capture Ray™** technology also significantly reduces the odors discharged outdoor and thus lowers the kitchens' environmental impact on the neighborhood and the risk of complaints or legal action.
- The **UV On Demand** option activates the lamps only when cooking appliances are actually used. It saves up to one lamps-set where other UV systems require two.

Other features and benefits

- Construction compliant with NF EN 16282-2 (5).
- Integrated fan for the **Capture Jet™** technology. No additional duct is required.
- Capture Jets are automatically switched off when the hood is not used or operates at a minimum airflow.
- Total access security to UV-C lamps that includes the detection of each filter presence.

- Advanced 24/7 distant monitoring capabilities thanks to **Halton Connect** IoT (Internet of Things) platform.
 - Highest value of ownership thanks to **Halton Connect & Care** smart services available as an option from kitchens commissioning.
 - **Halton Skyline** (HCL) LED culinary light provides the best visual comfort while contributing to further improve safety and energy savings.
 - When extended to the whole kitchen and surrounding areas, the Human Centric version of **Halton Skyline** (HCL) directly contributes to chefs' and their teams wellbeing.
 - Exhaust airflow rates are determined using an EN 16282-1 based calculation method, which takes into account the loads of the cooking or dishwashing equipment, the makeup air strategy, the configuration of the hoods or ventilated ceilings, and their capture and containment efficiency.
 - Capture and containment efficiency tested in accordance with the ASTM 1704 standard.
 - Quick and easy commissioning. Hoods delivered "ready to install", with all accessories included, such as light fitting, T.A.B.™ airflow measurement taps, and dampers for quick balancing on-site.
 - Sturdier and easier to clean (less parts and fewer joints). Stainless steel construction.
- (1) LEED - Leadership in Energy and Environmental Design (2) BREEAM - Building Research Establishment Environmental Assessment Method (3) DGNB - German Sustainable Building Council (4) RE2020 - French Environmental Regulation 2020 (5) NF EN 16282-2 Equipment for commercial kitchens - Components for ventilation in commercial kitchens - Part 2 : kitchen ventilation hoods - Design and safety requirements (6) HACCP - Hazard Analysis Critical Control Point



Capture Jet™ technology

◦ High capture efficiency ◦ Energy savings



The *Capture Jet™* technology enables significant reductions in airflow rates leading to savings on construction costs, mainly due to the reduced size of ducts and HVAC equipment. It typically pays for itself upon the startup of the kitchen or within few months. The energy savings it generates then directly contribute to an increase in profitability, while the staff benefits from improved working conditions.

Benefits

- The *Capture Jet™ technology* allows for up to a 40% reduction in exhaust airflow rates.

- No specific duct required for the Capture Jets. In addition to the reduction of the ducts and HVAC systems size, it reduces installation cost and the CapEx.
- It generates important energy savings on cooling/heating the makeup air (less air out, less air in!).
- The reduction of the draft risk and noise levels improves the working conditions for the staff.

How does it work?

The Capture Jet™ technology is based on the use of one or several sets of aerodynamic nozzles, supplied with an extremely low airflow.

These nozzles form one or several air curtains. Carefully located and oriented, they prevent the grease, steam, smoke and heat etc. released by the cooking appliances from escaping and orient them toward the filters. It is this capture efficiency improvement that enables the ventilation volumes.

UCH hoods are equipped with dual nozzles on the front and sides.

Schlieren tests on a Halton hood with the Capture Jets ON and OFF



The Schlieren system shows the convective flows of cooking appliances so that the hoods' capture efficiency can be reliably and objectively measured.

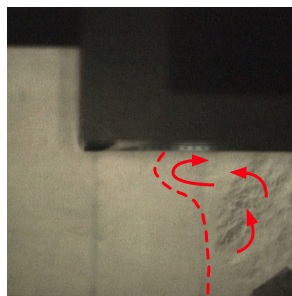

Capture Jets ON @3600 m³/h.
The convective flows do not escape on the hood front. They are efficiently extracted.

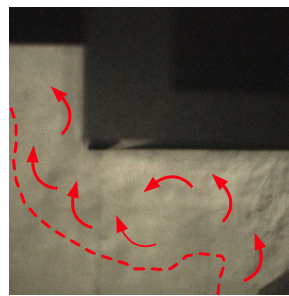

Capture Jets OFF @3600 m³/h.
With a traditional hood, a significant part of the convective flows escapes.

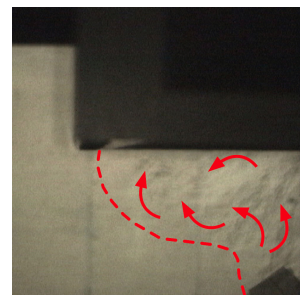

Capture Jets OFF @6000 m³/h.
With 2400 m³/h more airflow, a traditional hood captures again all convective flows.



KSA aerosol separator

◦ Cyclonic effect ◦ Reduced cleaning costs ◦ Improved safety



KSA cyclonic aerosol separators efficiency limits grease and particles deposition inside the exhaust plenums of Halton's hood and ventilated ceilings and in the ductwork. They are a cost effective solution to reduce the duct cleaning costs while directly contributing to a better hygiene and fire safety.

Benefits

- KSA cyclonic aerosol separators constructed of stainless steel in compliance with EN 16282-6. Up to 95% efficient on 10 microns particles or larger with a reasonable pressure loss of 120 Pa.
- KSA separators' flame-behaviour also complies with UL 1046 and LPS 1263 standards. They also have NSF (National Sanitation Foundation) hygienic and safe approval.

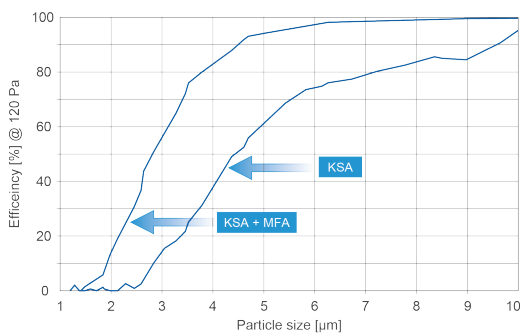

Tests on KSA aerosol separators' efficiency carried out on a Halton hood exhaust plenum by VTT laboratory, according to VDI 2052 (part 1). Efficiency tests on the combination KSA+MFA made in a Halton R&D laboratory with similar conditions.

- Improved hygiene and fire safety thanks to fewer grease deposits in the ducts.
- Lower maintenance costs due to reduced cleaning frequency.
- Reduced noise levels and fans' energy consumption thanks to the low pressure loss compared to baffle filters.
- Improves the performance of UV-C Capture Ray™ technology due to its high extraction rate.

How does it work?

KSA cyclonic filters are composed of vertical honeycomb profiles, opened only at top and bottom part. This design forces the air to swirl in a similar way as a cyclone when the air goes up and down inside to escape.

The centrifugal effect is impactful, and continuous – a mechanism that traditional baffle filters do not have. Particles are thus projected against the honeycomb walls, resulting in better separation performance.

KSA Aerosol Separators are essential for Capture Ray™ hoods and ventilated ceilings, so that UV-C lamps only have to deal with the small to medium sized particles.

On UCH-I hoods, the KSA aerosol separators are combined with MFA mesh filters to bring the efficiency on 5 microns particles to up to 94%.



Visualization of the cyclonic effect inside the KSA aerosol separator's profiles (Schlieren test).



Capture Ray™ technology

◦ UV-C grease and odors neutralization

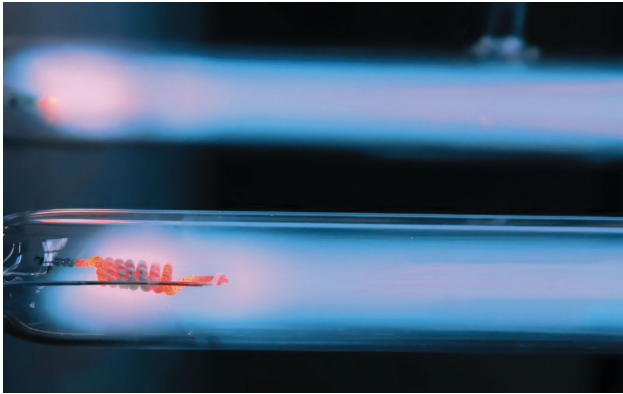

The *Capture Ray™* technology neutralizes the small grease particles, the grease vapors and a portion of the VOCs that can't be removed by any primary mechanical filtration. It truly represents a unique ensemble of benefits, from savings on cleaning costs to optimal hygiene and fire safety levels, through to lower kitchens' environmental impact on the neighborhood.

Benefits

- The *Capture Ray™* technology keeps the exhaust plenums and ductwork virtually free of grease deposits. The ductwork cleaning operations are cut down to the minimum legal frequency (if applicable) or to the strict minimum, leading to important savings.
- Hygiene and fire safety levels of the extract circuit are moreover kept at an optimum level.
- The *Capture Ray™* technology also significantly reduces the odors discharged outdoor and thus lowers the kitchens' environmental impact on the neighborhood and the risk of complaints or legal action.
- An asset to establish a restaurant in dense urban sites i.e. in previously unfeasible locations or where they represent the highest turnover potential.
- When combined with PolluStop, airborne cooking odours will be minimized to a point that the ductwork can then follow the most direct and cost-effective route to outside, even at street level.
- It allows for the elimination of unsightly external or bulky internal vertical duct risers. It reduces the installation costs and increases the leasable space and corresponding revenues.
- The Capture Ray™ technology also allows for efficient heat recovery, sustainable over time.

How does it work?

Capture Ray™ technology is based on the use of UV-C lamps. The Neutralisation of grease particles and vapors depend on two simultaneous reactions.

Photolysis is the direct effect of UV-C radiation. It works by photodecomposition whereby grease molecules are broken down by photons.

Ozonolysis is the oxidation of the molecule fragments by the ozone generated by the lamps. The final products of this reaction are water, carbon dioxide, and an inert residue from a polymerization-like reaction. Since ozone is a gas, it is carried with the airflow, allowing oxidation to continue in the extract ductwork.

The UV-C lamps also neutralizes a portion of the VOCs, the second odor propagation vehicle with grease.

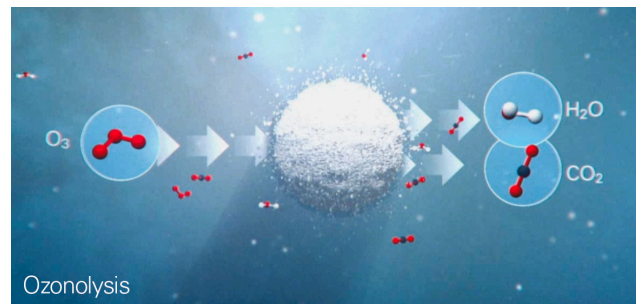
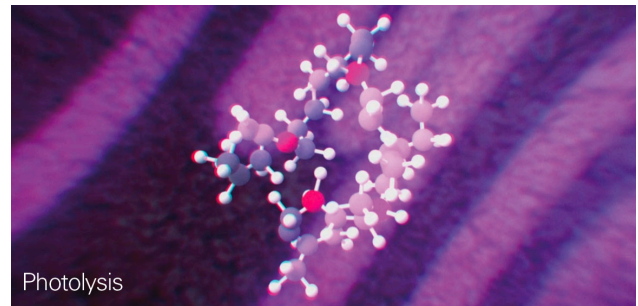

View inside an exhaust plenum fitted with UV-C lamps after several weeks of use



UV on demand technology (option)

- UV Lamps life time increase



Halton developed a technology that monitors, in real time, the cooking appliances activity, thus activating the UV lamps only when it is strictly required.

Benefits

- Up to one in two sets of UV-C lamps saved.
- Saves on both the maintenance costs and the energy consumption.

How does it work?

Halton has developed an advanced Thermal Imaging sensor (HTI) to scan the surface of the cooking appliances, to determine whether the appliances are off, on but idling or in cooking mode.

In the heart of *M.A.R.V.E.L.* airflow and energy optimization technology, HTI sensor is also in the heart of Halton's "On Demand" technology whose objective is to place sustainability to the forefront. They are then generally used to save energy, water and also on maintenance costs.

The "UV On Demand" technology enables activating the UV lamps only in cooking mode and not continuously, as soon as the fan is switched on. This is a safe and responsible approach that enables delaying the UV-C lamps replacement. It significantly reduces the maintenance costs while also saving energy.

When UV hoods or ventilated ceilings are also equipped with *M.A.R.V.E.L.*, the "On Demand" option becomes standard.

One in two sets of UV-C lamps saved and 635€ electricity savings a year on only two hoods installed in a restaurant, central London.



- The restaurant is equipped with two UV Capture Ray™ hoods (6 UV lamps each) and a PolluStop exhaust air handling unit. It opens 88 hours a week.

- The cooking block comprises two griddles, 2 fryers and a fry scuttle for a total electric power of 50 kW. The cooking appliances operate 92 hours a week. The UV lamps of a traditional system are on while the main fan is running – 92 hours per week too.
- Over 4 weeks monitoring, the UV on Demand technology reduced the number of operational hours of the lamps by an average of 44% (up to 50% depending on cooking appliances use). In other words, and compared to the maintenance cost of the traditional systems, it saves up to one UV lamps replacement out of two.
- The electricity consumption of the lamps was reduced by 47 kWh per week which represents 635 € a year (0,26€/kWh).



Halton Skyline

◦ Culinary and Human Centric light



Halton Skyline is the first LED lighting technology specifically developed for the needs of commercial kitchens, starting with staff's comfort. The light it provides is the closest possible to natural light thus offering many tangible benefits.

How does it work?

Halton Skyline is based on the use of two types of light sources, both equipped with the latest generation of highly efficient LEDs.

A broad beam spot (4000K - CRI of 83) - It is designed to provide a uniform and bright general lighting. For the most advanced Human Centric version, it is equipped with two sets of LEDs to make the color temperature varying from 2200 to 6500K. This enables creating daylight-similar sequences to offer lighting conditions that are Circadian rhythm-friendly, with

recognized biological and psychological benefits for the staff.

A focussed beam spot (2800K - CRI of 95) - It is used to further improve the lighting level and the color render of the food in strategic locations, above cutting machines or griddles for instance, or even the plating presentation area.

Halton Capture Jet™ hoods' light fittings are equipped with Halton Skyline broad beam spots (4000K colour temperature).

Benefits

- Very good illuminance levels and uniform light, with a good balance between the direct and diffuse components.
- Remarkably respects the natural food color and texture.
- Improved safety and best visual comfort, without alteration over time.
- Consumes up to 2,8 times less than fluorescent tubes while having a luminous efficacy of 120 lm/W.
- 50,000 hours lifetime for both the LEDs and the drivers.
- Saves the replacement of up to 125% of the fluorescent tubes, adding significant maintenance savings to the energy savings.

Integrated in Halton's suspended metal ceilings or thanks to standalone modules, Halton Skyline can be extended to the whole kitchen and beyond. It then opens the way to the most advanced and Human Centric lighting global solution.





Halton FireWatch

◦ Enhanced fire prevention ◦ Part of Halton SafeGuard



Halton FireWatch adds a prevention level to Fire Suppression Systems by detecting conditions favorable to a cooking fire before extinguishing is triggered. Get peace of mind on your fire safety.

How does it work?

Halton Fire Watch is based on Halton's Thermal Imaging Sensor that continually monitors the surface temperature of the cooking appliances for abnormalities that are a precursor to a fire event.

When a risk is detected, Halton's touchscreen (combined with optional visual or audible alarm) alerts the kitchen staff to conditions that increase the likelihood of a fire. It recommends the actions before it breaks out and the fire suppression system

triggers. The system can go till switching off the cooking appliances' power supply.

Benefits

- Mitigates false fire system trips.
- Allows for intervention to reduce risk of fire starting.
- Avoid costly shut down and revenue loss from fire system discharge.
- Potential for insurance premium reduction.
- Cloud based data for insurance companies.
- Monitoring and data back-up services, free for the 1st year of use.
- Fully remotely customizable system to fit your needs when paired with Halton Connect.

Halton FireWatch is part of M.A.R.V.E.L., UV On Demand and Cold Mist On Demand technologies. It is also available as a standalone solution and can be installed in existing kitchens.

Halton FireWatch is part of Halton SafeGuard, the only holistic system that combines Energy Optimization, Indoor Environmental Quality (IEQ), and Safety, all together under one control platform.



Stage 1 alarm - A warning is displayed on Halton Touch Screen. It is relayed with light signal and buzzer fitted on the front of the hoods.

Stage 2 alarm - If the warning is not acted upon, an alarm is displayed

on the Touch Screen and its buzzer activates in addition to the one fitted on the hood. The fuel source can be automatically shut off.



Halton Connect®

◦ Advanced IoT platform for commercial kitchens



Halton Connect is a state-of-the-art IoT (Internet of Things) platform whose core is an advanced cloud-based portal. It enables 24/7 remote monitoring of the solutions designed by Halton, allowing access to useful information along with powerful data analytics.

Halton Connect enables Halton Care smart services. They directly contribute to the Highest value of ownership and peace of mind for the business owners.

Benefits

- 24/7 monitoring of Halton's technologies and solutions.

- Access to Halton Connect cloud-based and intuitive web portal included during the warranty period. It provides detailed information about all Halton's connected technologies and solutions.
- Automatic systems' faults notification and editing of simplified automated analytics reports.
- Option for advanced automated data analytics reports (energy savings, water savings, cooking appliances usage depending on the connected technologies etc.).
- Allows deeper analysis by our engineers in order to optimize set points or adjust the equipment utilization. The systems' efficiency can then be kept at design level or even improved during the entire kitchen(s) life cycle.
- Secure as designed to operate as a fully independent system in your building.
- Enables a predictive maintenance based on the data analytics of the systems. Visits are planned depending on the real needs and replacement parts use is optimized.
- Lowest risk of ventilation down time due to a wrong manipulation or equipment fault.
- Option for Software maintenance and update of Halton Connect.

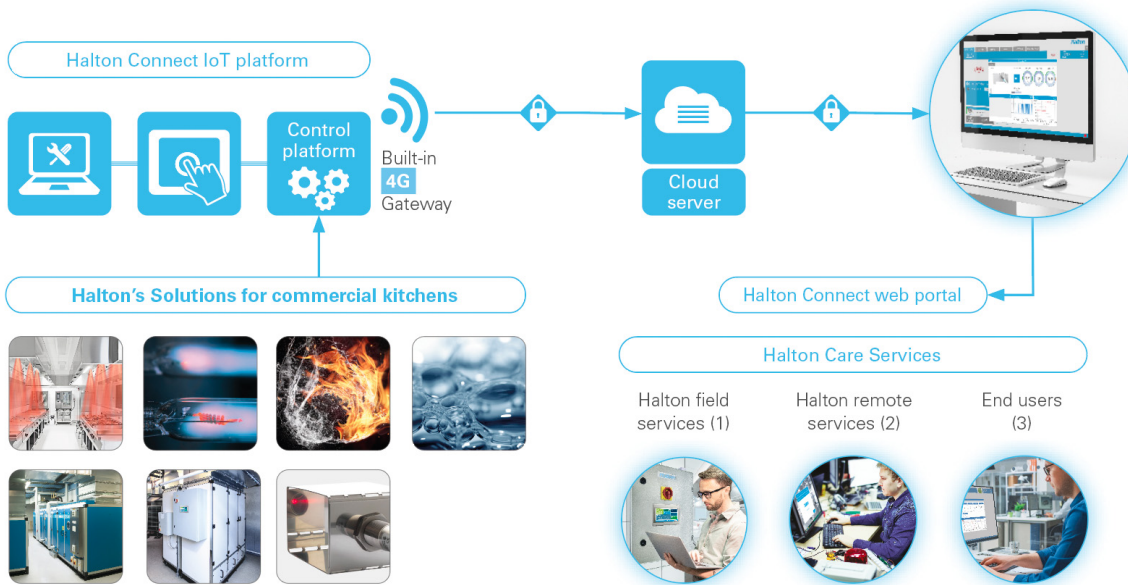

(1) Commissioning, maintenance, call centres, audits etc (2) Troubleshooting, systems optimisation, diagnostic etc (3) Business owners, supervisory, facility management staff etc



Halton Care (option)

◦ Smart services for commercial kitchens



Halton Care is a Premium Services offer, supported by our qualified field service teams and partners, and whose core is Halton Connect®. They directly contribute to the lowest total cost of ownership and peace of mind.

Halton Care Smart services for which benefits?

Services are often viewed as an expense. And yet, when ventilation and Indoor Environment Quality (IEQ) technologies are neglected, operating issues are sure to increase, costing even more, especially for commercial kitchens.

With Halton Care smart services, Halton solutions are maintained properly with savings on many aspects of kitchens operating, thus reducing the cost overall!

- Reduced energy and spare parts use.
- Reduced cleaning costs.
- Prevent hidden and irreversible damage of equipment.
- Reduce sick leaves of the staff.
- Eliminate complaints from the neighbourhood.
- No lost revenue due to down time.
- Increase hygiene and reduce fire risks etc.

Halton Connect web portal provides our service teams and engineers vital information enabling smart predictive maintenance. They can even optimize the operation of your systems by adjusting setting points or providing

recommendations to the kitchen staff such as equipment utilisation for even more benefits:

- Additional reduction of the energy and spare parts use.
- Visits are planned depending on the real needs and replacement parts use is optimized.
- Better view on the competitiveness through predictive costing.

Who better than Halton for Halton products?

Our service teams have close relationships with the end users, our R&D engineers as well as our manufacturing and installation teams. This intimacy enables Halton to continually improve our solutions and technologies to make them more efficient but also user and maintenance-friendly.

Less onsite interventions also means less human contact on site



Halton Care smart services enables fixing most of the system faults reported remotely, by a simple call to advise the kitchen team what actions to take or by upgrading the controllers' settings or software.

All that remains are interventions for consumables and other spares replacement and general maintenance. Peace of mind at all respects.

Construction

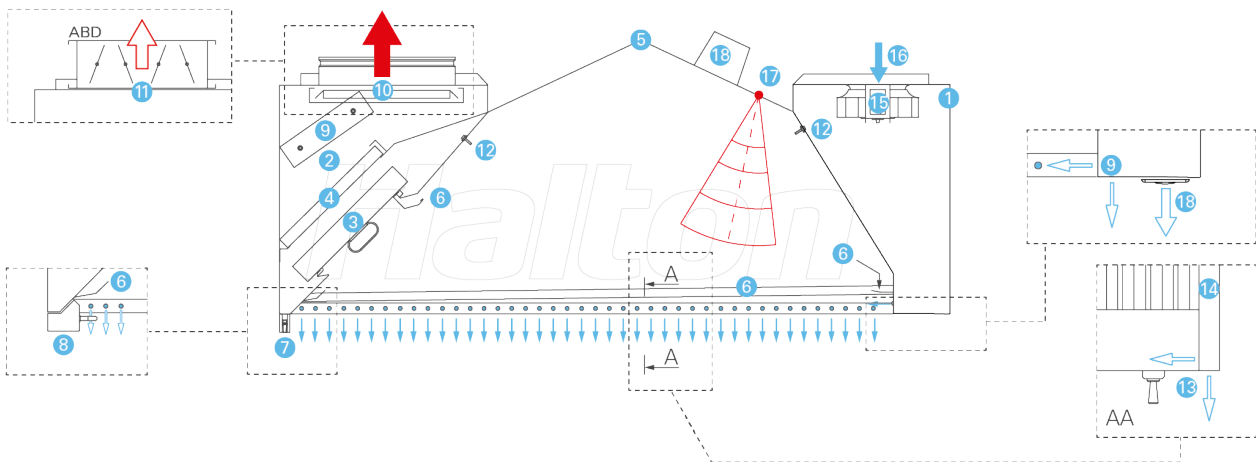

1. Visible outer envelope in stainless steel AISI 304 (1,0 mm).
2. Exhaust plenum.
3. KSA aerosol separators.
4. MFA filters as second filtration stage.
5. Special diamond-point shaped roof.
6. Perimeter gutter system.
7. Condensates drain.
8. Collection tray as an option.
9. UV-C lamps rack mounted on runners for an easy removal. UV-C lamps rack mounted on brackets
10. Exhaust connection(s) and sliding damper(s).
11. When the kitchen is equipped with M.A.R.V.E.L. airflow and energy optimization technology (MRV), the sliding damper is replaced by ABD automated balancing slim damper.
12. T.A.B.™ (Testing And Balancing) pressure port(s) for quick airflow calculation during ductwork balancing operations.
13. Front Capture Jet™ nozzles.
14. Double skin sides.
15. Integrated Capture Jet™ fan.
16. Capture Jet™ fan air inlet.
17. Halton IRIST™ infrared sensor (used for the optional M.A.R.V.E.L., UV on Demand or FireWatch technologies). (used for the optional M.A.R.V.E.L. or UV on Demand technologies).
18. Halton Skyline LED culinary LED spots flush-mounted on the hood roof.

M.A.R.V.E.L. ready option: To allow for later installation of M.A.R.V.E.L. airflow and energy optimization, each hood can be equipped only with its ABD slim automated balancing damper, which is typically very difficult to install afterward.

Dimensions

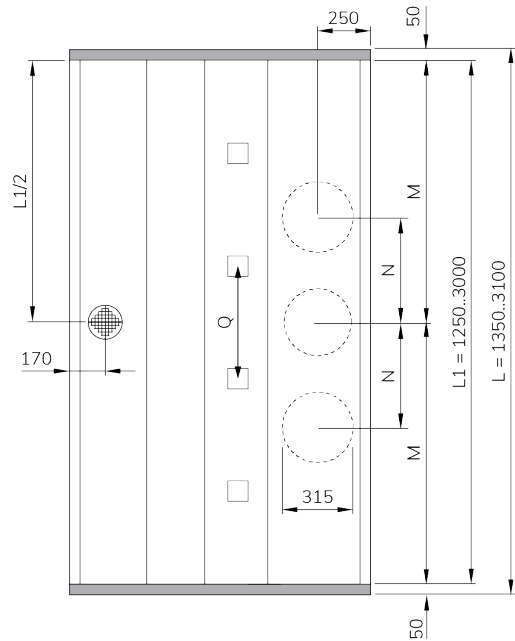
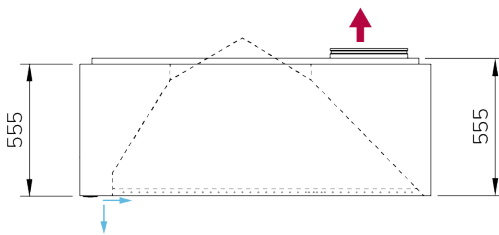
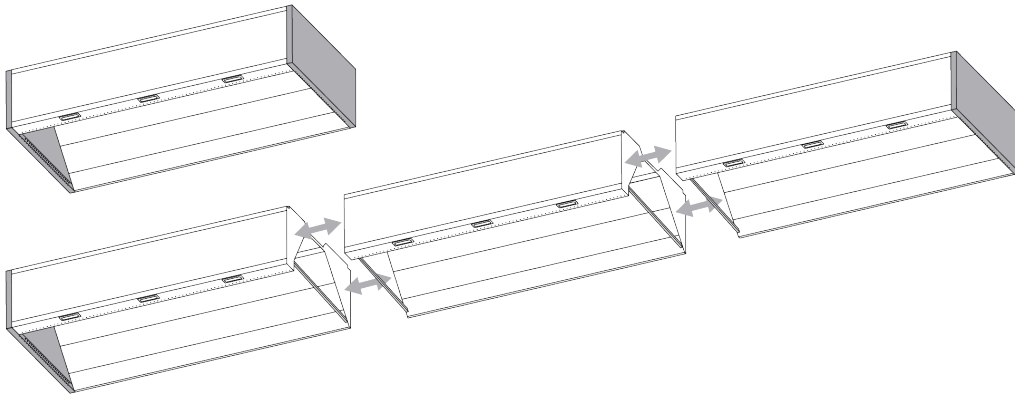

[mm]	1x	2x	3x	
L	M	N	M, N	Q
1350	L1/2	-	-	500
1600	L1/2	275	-	500
2100	L1/2	275	-	500
2600	-	275	L1/2, 550	500
3100	-	275	L1/2, 550	500

- Above 3100 mm, hoods are an assembly of separate sections to make transportation and site handling easier.
- Number of connections to be determined based on the sections length and on the calculation of the airflow rates (depending on the cooking appliances).
- Rectangular connections on request.

Admissible and calculated airflows

Admissible airflows

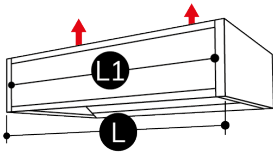

L	L1	KSA	↑ Q _E min..max ⁽¹⁾		↓ Q _{CJET} ⁽²⁾	
[mm]	[mm]	[Nb]	[m ³ /h]	[l/s]	[m ³ /h]	[l/s]
1600	1500	3	1515...2055	420...570	97	27
2100	2000	4	2020...2740	560...760	112	31
2600	2500	5	2525...3425	700...950	127	35
3100	3000	6	3030...4110	840...1140	142	39

(1) Q_E Min..Max/KSA = 505..685 m³/h | ΔP_{T.A.B.} Min..Ma = 50..91 Pa

(2) Side Jets with W=1300 mm

Calculated airflows

The calculated exhaust airflow rates are determined with a EN 16282-1 based calculation method. It relies on the evaluation of the convective flows' volume (air mixed with heat, steam, grease, smoke and other pollutants) generated by the cooking appliances, depending on their type, on the energy they use and their installation conditions (central, on a wall, in an angle).

The air volume required to remove the convective loads is then calculated depending on:

- The hood or ventilated ceiling installation height;
- The makeup-air strategy (mixing or displacement);
- The hood or ventilated ceiling capture efficiency according to ASTM 1704-12 standard.

UCH-I hood reduces the exhaust airflow rates⁽¹⁾ by up to 40% compared to traditional hoods.

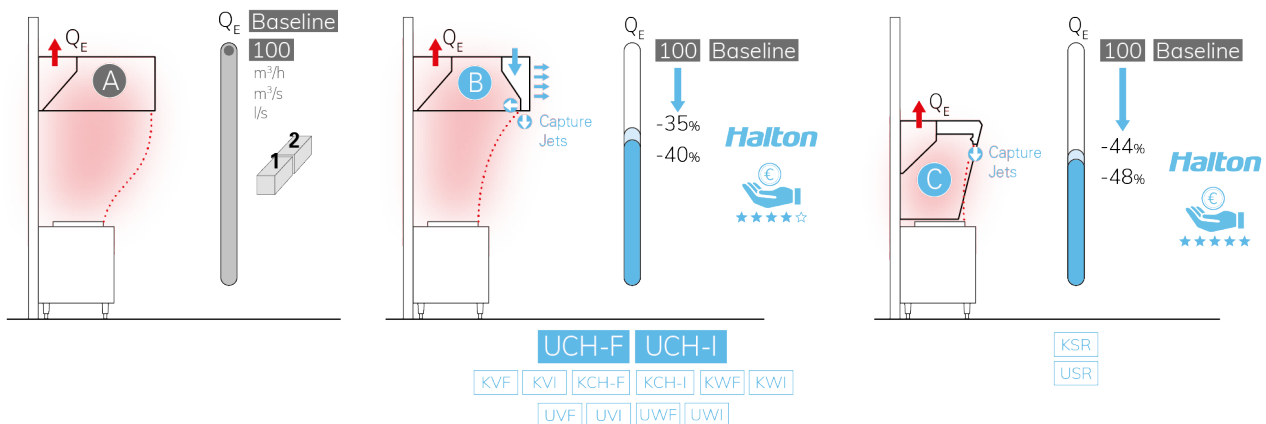

(1) This scale is indicative and based on wall mounted hoods, opened on 3 sides, equipped with a same cooking bloc, whatever it is. The variation in exhaust airflow reduction for a given hood type is due to the makeup-air type (mixing or displacement). Other parameters do impact the final airflow rates. Our sales teams are at your disposal to provide you with a calculation note, depending on your kitchen configuration.

Halton Connect® network principles

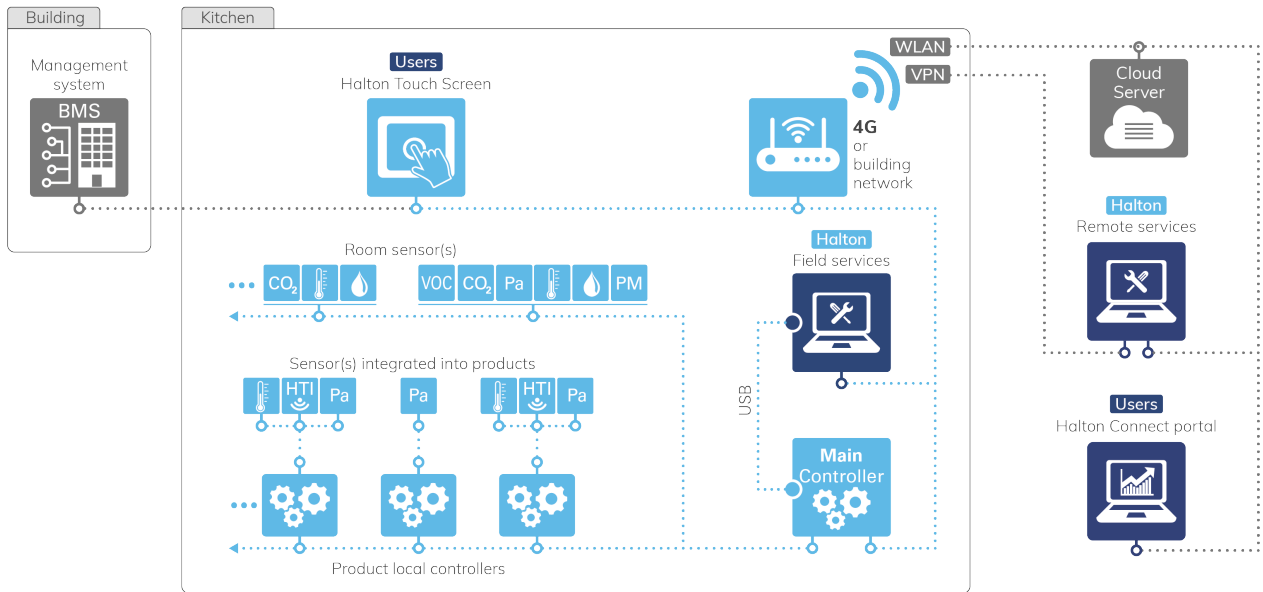

These information are also available on Halton Connect® web portal, in the same manner as those of the Halton solutions that may equip the other building areas.



The built-in 4G gateway of Halton Connect is designed to operate as a fully independent system in your building. The data traffic toward the cloud is secured by a VPN (Virtual Private Network) and with SSL encryption protocol (Secure Sockets Layer).

Halton Connect also has the ability to send information to the BMS (Building

Management System).



Read our white paper about Halton Connect Secure

Green Steel label



Manufactured with decarbonized stainless steel (option)

Halton's innovations are recognized for significantly improving its customers' carbon footprint from day one of operation. However, sustainability and low environmental impact require manufacturing these solutions with the lowest possible carbon footprint.

As of the second half of 2024, and initially for Europe, Halton progressively offers the possibility to manufacture its Capture Jet™ hoods with decarbonized stainless steel as an option.

CO₂ emissions reduced by 60%! This is the carbon footprint average reduction achieved for this green steel, with the same mechanical properties. Per ton, it represents 850 kg CO₂ less or the equivalent of 4595 km with a thermal car, 5600 km for a medium-haul plane or 423636 km with the French fast train, powered with decarbonized electricity (1).

(1) According to the ADEME ([The French Agency for Ecological Transition](#)) resource site which popularizes and promotes environmental data.

Pressure losses and sound levels (exhaust)

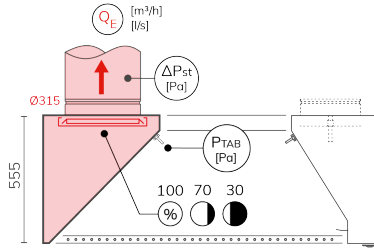
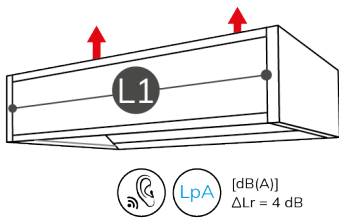

L1 = 1000 mm ΔP_{st} LpA f Q_e (%)
 2 KSA 2 MFA

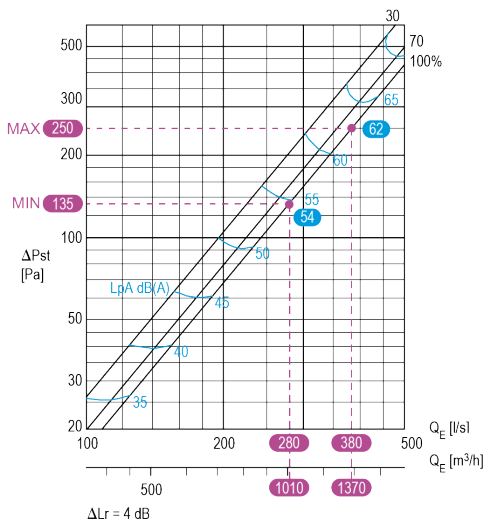

L1 = 1500 mm ΔP_{st} LpA f Q_e (%)
 3 KSA 3 MFA

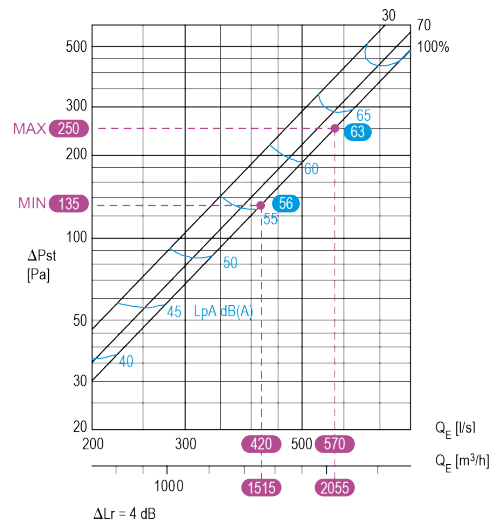

L1 = 2000 mm ΔP_{st} LpA f Q_e (%)
 4 KSA 4 MFA

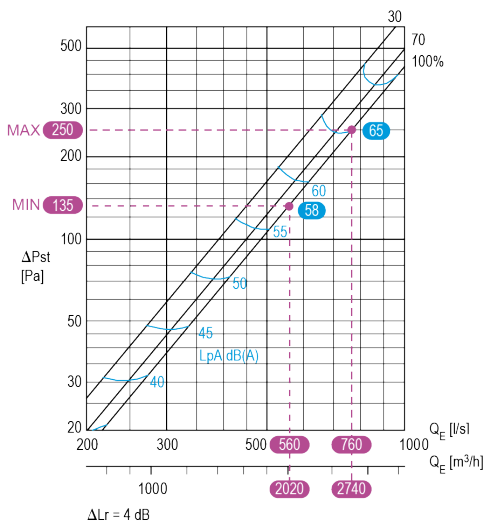

L1 = 2500 mm ΔP_{st} LpA f Q_e (%)
 5 KSA 5 MFA

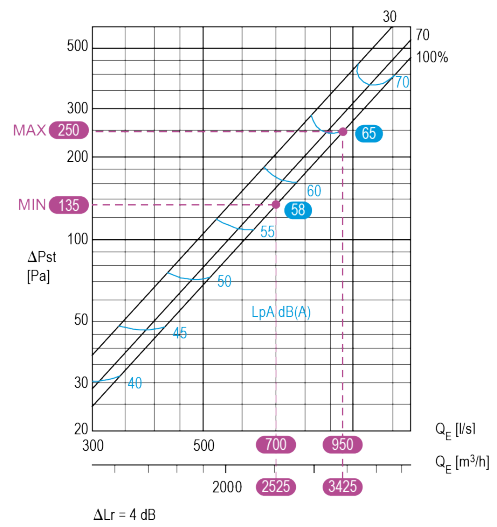

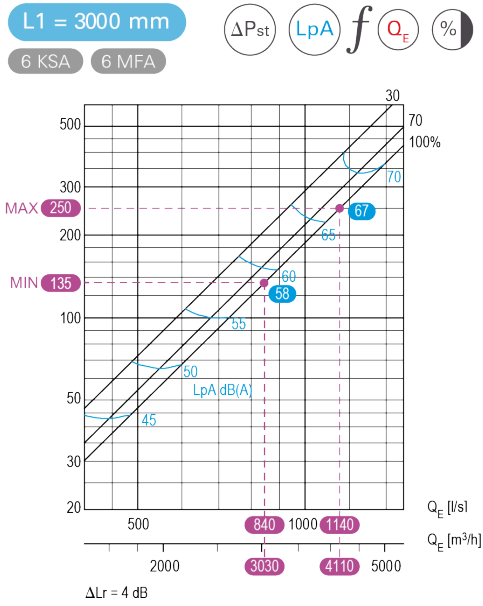

Airflow measurement (T.A.B.™ reading or use of hood k factor)

Q_E f P_{TAB} $L1$

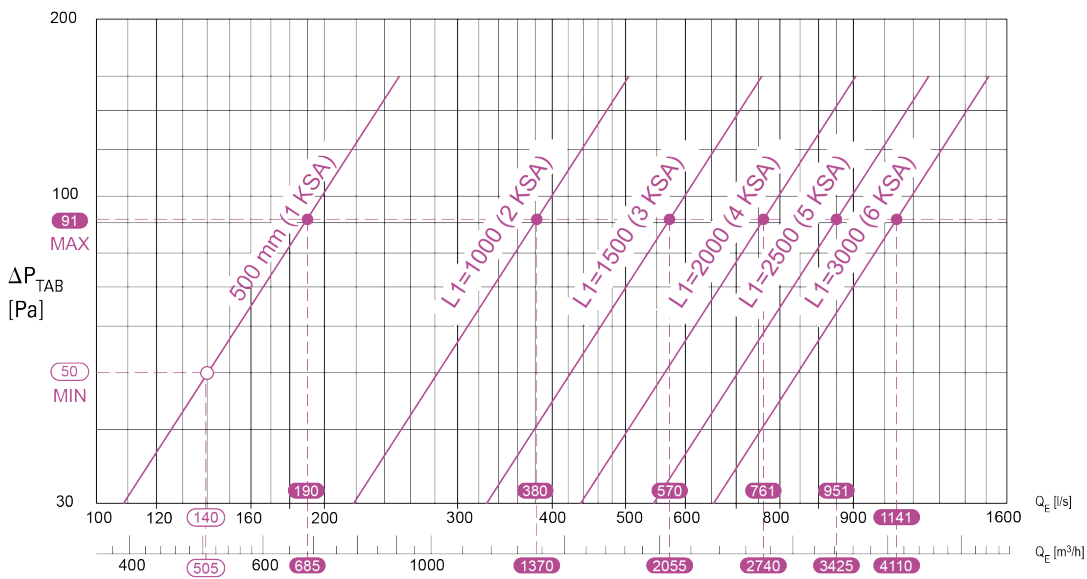

Q_E f P_{TAB} k

$$Q_E = k \times \sqrt{P_{TAB}} \text{ [Pa]}$$

KSA+MFA	k [m³/h]	k [l/s]
1	49,7	13,8
2	99,4	27,6
3	149,1	41,4
4	198,8	55,2
5	248,5	69
6	298,2	82,8

Suggested specifications

UCH-F / UCH-I

The hoods shall be Halton brand - range UCH-F / UCH-I. They shall be specifically designed for heavy steam producing equipment.

- UCH-I is the extract-only model.
- UCH-F is equipped with an integrated makeup air system on the front.

The hoods shall be supplied ready to be installed. All technologies and systems shall be delivered fully pre-wired.

The following specifications shall be fully observed.

Capture Jet™ technology

- The Capture Jet™ technology is based on the use of sets of aerodynamic blowing nozzles. Each set forms an air curtain that is used to increase the capture and containment efficiency on smoke, steam and heat.
- The exhaust airflow rates shall thus be reduced by up to % while removing the same heat, steam and smoke load compared to traditional systems.
- The nozzles shall be designed to get a high air speed at output while not creating draughts that could have an opposite effect to that expected. They shall not represent more than 5% of the calculated exhaust airflow rates.
- The Capture Jets shall be fed with an integrated fan, in order to provide the airflow and static pressure required for an optimal efficiency. A specific ductwork is thus not required.
- [Option] The Capture Jet™ fans shall be controlled by a pressure switch to stop it when the kitchen exhaust is off or at minimum speed.

Exhaust airflow rates

- The exhaust airflow rates shall be determined with an EN 16282-1⁽¹⁾ based calculation method. Hence, they shall take into account:
 1. the convective loads released by the cooking appliances, whether they are characterised by the EN 16282-1, the manufacturer or a third party;
 2. the type and installation configuration of the exhaust device(s).
- The calculation method shall, in addition, consider the capture efficiency of the exhaust devices according to ASTM 1704 standard.
- Both the exhaust airflow rates, and capture efficiency shall be justified by a calculation note.

- Any modification of the exhaust devices' installation height or of the input power, type and dimensions of the cooking appliances shall be brought to the attention of the manufacturer as they all significantly impact the exhaust airflow rates.

Makeup air design

- The makeup air design, especially the diffusers type, size, and location as well as the means to get a correct balance between exhaust and supply, shall be entrusted to the manufacturer. It impacts the exhaust airflow rates, the capture efficiency and is also key to preventing cross-contaminations.
- The makeup air shall be as much as possible managed by way of the diffusers integrated in the hoods' front. If their capacity does not cover the total needs of the kitchen, the additional diffusers shall be of laminar-flow type.

Outer casing and general

- The construction shall be compliant with NF EN 16282-2.
- The hood's roof shall have a diamond-point shape to facilitate the drainage of condensation droplets toward a gutter system.
- The gutter system shall be installed on the four sides of the lower part of the hood's containment volume, with an additional gutter above the exhaust plenum's aerosol separators. All gutters shall be connected to the hood's exhaust plenum to evacuate the condensation.
- Constructed from 1.0 mm AISI 304 (DIN EN 1.4301) stainless steel, with a 320 grit on the visible side.
- The joints of the lower edges shall be fully welded for better robustness, cleanability and a better aesthetic.
- All exposed welds are ground and polished to the metal's original finish.
- Sides shall be double-skin.

Exhaust plenums

- Constructed from 1.0 mm AISI 304 (DIN EN 1.4301) stainless steel, with a 320 grit on the visible side.
- The lower part of the plenum's sides shall be welded for a durable tightness to condensates.
- The aerodynamic shape of the plenums' bottom part shall help the smoke and steam freely rising up without stagnating. This contributes to prevent the build-up of condensation drips that risk falling down on the cooking appliances.

- The exhaust plenums shall be equipped with KSA cyclonic aerosol separators. Their efficiency shall be at least 95% on 10 microns particles or larger, as tested by an independent laboratory. Constructed from stainless steel, they shall comply with EN 16282-6. They shall also be certified UL 1046, NSF and LPS 1263.
- KSA aerosol separators shall be combined with MFA mesh filters. Resulting efficiency of up to 99% on 10 microns particles or larger, and 94% on 5 microns particles.
- The exhaust plenums shall be equipped with UV-C lamps fitted in a cassette installed right after the mechanical filtration.
- Ballasts shall not be integrated in the cassette to prevent a possible overheating and also to make it lightweight and easy to handle.
- The rack shall be mounted on runners and be equipped with quick release electrical connectors (without tool).
- The UV-C cassette shall be easily accessible for cleaning and maintenance, without tool and without having to remove the filters, by the mean of an access door equipped with lock handles.
- Lamps lifetime shall be at least . Length of the UV-C lamps upon manufacturer recommendation.
- The plenum shall be equipped with a T.A.B.™ (Testing And Balancing) pressure tap for quick airflow measurement.

Security access to the UV-C lamps

- The exhaust plenum shall be equipped with maintenance-free magnetic proximity switches in order to individually check the presence of each aerosol separator. Pressure switches shall not be used to that purpose.
- Any access attempt to the UV lamps, whatever the circumstances, shall automatically lead to their automatic shut-off and to an alarm.
- The control system shall include a pressure sensor to automatically switch off the lamps in case of fan shut down or unusual low pressure. A complementary interlock between the exhaust fan and the UV control system shall be set up, preventing in all cases the UV lamps to be on when the fan is off.
- Each hood section shall be equipped with a UV module comprising the controllers and ballasts.

[Option] UV on Demand

- To extend the UV-C lamps usage period before replacement, the system shall be equipped with the UV on Demand technology.
- It shall be based on Halton Thermal Imaging (HTI) sensor(s) that monitor, real time, the variations in cooking activity. It shall enable to automatically activate the UV-C lamps during cooking processes only.

[Option] Airflow optimization technology

- The exhaust hoods shall be equipped with an airflow optimization technology. It shall be Halton Brand, MRV (M.A.R.V.E.L.) model.
- The optimization technology shall automatically adjust the exhaust airflow rates, depending on the cooking activity, in real time and independently. If only one cooking zone is operating, only the airflow required for that zone would be automatically adjusted. The other zones shall continue to operate at a low flow rate.
- Refer to the specific description.

IoT Control Platform

- The IoT (Internet of things) control platform shall be Halton Brand, Halton Connect.
- It shall have advanced distant monitoring capabilities to provide detailed information about the system(s) operation and statuses, thanks to a cloud-based and easy to use web portal.
- The IoT platform shall also include a Touch Screen providing the users simple information about the unit's operation and its maintenance, without the need to connect the web portal.
- Refer to the specific description.

[UCH-F] Integrated makeup air

- The hoods shall be equipped with an integrated low-velocity diffuser on the front for the make-up air.
- The diffusers' plenum shall be equipped with dampers of MSM type used to adjust the supply airflow and also to get a uniform distribution of the air inside the plenum. The air shall be then streamlined by the mean of a "honeycomb" structure and the perforated facade.
- The facade and honeycomb structure shall be easy to remove for cleaning and maintenance operations.
- The internal face of the plenums shall be insulated to avoid any risk of condensation on the containment volume side.
- The plenum shall be equipped with a T.A.B.™ (Testing And Balancing) pressure tap for quick airflow measurement.

Light fittings

- The hoods shall be equipped with Halton Skyline LED wide-beam spotlights, glued flush-mounted on the diamond-point ceiling.
- The illuminance on the working surfaces shall be at least 500 lx.
- The spots shall provide a uniform light, with good balance between the direct and diffuse components, to make forms and textures clearer and richer in contrast without dazzling the staff.
- The spots' shielding angle shall exceed the specification of EN 12464-1 and be greater than 30° while its Unified Glare Rating (UGR) shall be lower than 19.

- They shall have a color temperature of 4000K and a Color Rendering Index (CRI) of at least 83.
- The LEDs and drivers lifetime shall be at least 50,000 hours. The drivers shall be DALI compatible. The spots' efficiency shall be at least of 105 lm/W.
- The spots shall be closed by a seamlessly glued safety glass plate for a better hygiene and ease of cleaning. Its protection against water spraying shall be IP54. The glass shall be fire-rated A1 i.e. non-flammable according to EN 13501-1.
- As standard, the power supplies shall enable switching on/off or dim the light (1-100%) with one or several switches.
- **[Option]** A specific DALI user interface, with scenario and zoning functions, shall be used to control the light fittings.

[Option] Fire prevention Halton FireWatch

- The system shall be equipped with Halton FireWatch prevention technology
- Based on Halton Thermal Imaging (HTI) sensor, it shall continually monitor the variations in surface temperature for the cooking appliances and the temperature in the exhaust plenum to detect abnormalities that are a precursor to a fire event.
- The system shall alert the user of conditions that increase the likelihood of on a Halton Touch Screen that shall also recommend to take action before the the shutdown of equipment or discharge of the fire suppression system.

- The alarm shall be relayed with an external visual and/or sound indicator.

[Option] Fire Suppression System

- The fire extinguishing system shall be the Ansul® R-102™ or Piranha type.
- It shall be pre-installed from the factory for better integration.
- The detection chain and fusible link(s) shall be fully integrated inside the exhaust plenums to not be visible.
- The nozzles and pipework used inside the exhaust plenums, at the connections to the ductwork and above the cooking appliances shall not block or obstruct any of the extract devices' components neither interfering with their operation, whether during commissioning or maintenance.
- Unless technically impossible, no horizontal pipework shall be visible inside the containment volume of the extract devices or run along the exhaust plenums. The nozzles shall drop directly from the top of the exhaust devices equipped.
- The commissioning shall be carried out by the hood manufacturer or a certified partner. In all cases, it shall be an authorised representative of Ansul, and the installation shall comply with UL 300 requirements and local codes.

(1) The European Standards published by CEN are developed by experts, established by consensus and adopted by the Members of CEN. It is important to note that the use of standards is voluntary, and so there is no legal obligation to apply them (source: CEN).

halton.com

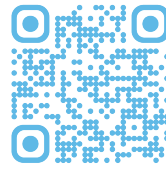
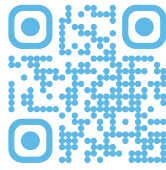

Halton Manufacturing and Sales Facilities in the world

 Sales and service centers

 Representatives

 Factories

 Manufacturing licences

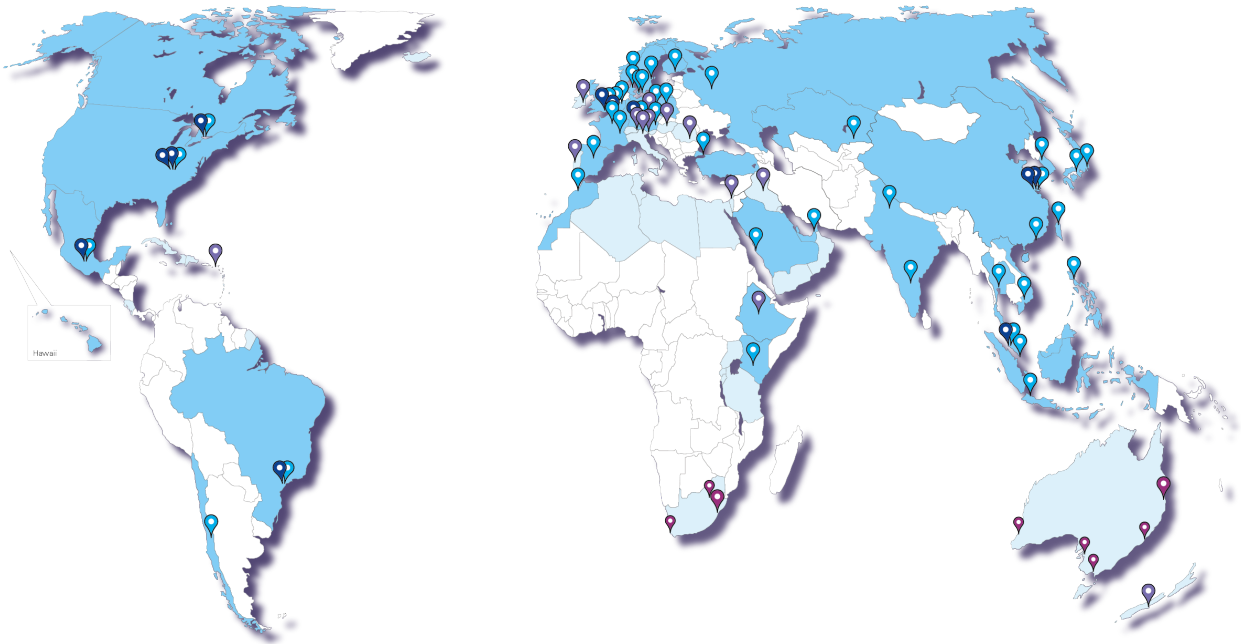

Halton Foodservice partnerships

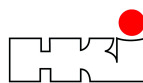

Halton has a policy of continuous product development, therefore we reserve the right to modify design and specifications without notice. For more information, please contact your nearest Halton agency. All rights reserved. No part of this publication may be reproduced, distributed, or transmitted in any form or by any means, including photocopying, recording, or other electronic or mechanical methods, without the prior written permission of the publisher, except in the case of brief quotations embodied in critical reviews and certain other non commercial uses permitted by copyright law.