

KCH-F

Capture Jet™ condensate hood with supply air

◦ For heavy steam-producing equipment ◦ Capture Jet™ technology ◦ KSA aerosol separators ◦ Halton Skyline LED Lighting ◦ Integrated low velocity makeup air



Product certification(s)



Components certification(s)



Main technologies and options



Anti drips design
Prevents the formation of condensation drips for a better hygiene



Capture Jet™ technology
Up to 40% reduction in exhaust airflow thanks to a better capture efficiency



KSA aerosol separators
Up to 95% efficient on 10 microns particles



Integrated low-velocity makeup-air
Better comfort and capture efficiency



HCL Halton Skyline
Daylight similar LED Culinary Lighting and human centric



Option for decarbonized stainless steel
An ecological and sustainable choice

Recommended combinations



Further increase the energy savings and improve staff's comfort <> Go for M.A.R.V.E.L. airflow and energy optimization technology



Don't risk bankrupt or business downtimes because of a cooking fire <> Go for FSS Fire Suppression System pre-installed from factory



Optimize the ductwork cleaning costs and further improve your safety <> Go for KGS grease deposition level monitoring system for ductwork

Description and main technologies



Applications

Halton Capture Jet™ hoods and ventilated ceilings are all suitable for [LEED](#) (1), [BREEAM](#) (2), [DGNB](#) (3), [RE2020](#) (4) etc. projects, particularly when combined with M.A.R.V.E.L. airflow and energy optimization technology. Specially designed for heavy steam producing equipment, they are particularly suitable to central kitchens, asian steam cooking and food industry.

Description

The *Capture Jet™* technology enables significant reductions in airflow rates leading to savings on construction costs, mainly due to the reduced size of ducts and HVAC equipment. It typically pays for itself upon the startup of the kitchen or within few months. The energy savings it generates then directly contribute to an increase in profitability, while the staff benefits from improved working conditions.

KCH hoods are also designed to evacuate the condensation drips that may form inside their containment volume when used with heavy steam-producing equipment. The hoods are equipped with a gutter system installed on all four sides of the containment volume. This system collects water drips flowing down the sides and the hood's ceiling, whose diamond-point shape facilitates their flow. These provisions greatly improve hygiene by limiting the risk of condensation drips falling on the cooking appliance.

KCH-F hoods are lastly equipped with a low-velocity makeup air built into the front face.

Considerable energy savings

- The *Capture Jet™* technology allows for up to a 40% reduction in exhaust airflow rates.
- The combination with M.A.R.V.E.L. airflow and energy optimization technology allows for reducing the exhaust volumes by up to an additional 44% on top of that of the *Capture Jet™* resulting in up to a **64%** total reduction.
- The energy savings on heating/cooling the makeup air then become massive (less air out, less air in!).

- The reduction of the draft risk and noise levels improves the working conditions for the staff.

Improved safety and maintenance savings

- Designed to channel excess condensation on hoods' interior surfaces to a perimeter gutter system to greatly improve hygiene.
- **KSA** cyclonic aerosol separators constructed of stainless steel in compliance with EN 16282-6. They are up to 95% efficient on 10 microns particles or larger. Also certified UL 1046, NSF, and LPS 1263.
- **KSA** aerosol separators It also results in savings on the ductwork cleaning cost.

Other features and benefits

- Construction compliant with NF EN 16282-2 (5).
- Integrated fan for the *Capture Jet™* technology. No additional duct is required.
- Capture Jets are automatically switched off when the hood is not used or operates at a minimum airflow.
- **Halton Skyline** (HCL) LED culinary light provides the best visual comfort while contributing to further improve safety and energy savings.
- When extended to the whole kitchen and surrounding areas, the Human Centric version of **Halton Skyline** (HCL) directly contributes to chefs' and their teams wellbeing.
- Better capture efficiency and comfort for the staff thanks to a low-velocity diffuser built into the front.
- Exhaust airflow rates are determined using an EN 16282-1 based calculation method, which takes into account the loads of the cooking or dishwashing equipment, the makeup air strategy, the configuration of the hoods or ventilated ceilings, and their capture and containment efficiency.
- Capture and containment efficiency tested in accordance with the ASTM 1704 standard.
- Quick and easy commissioning. Hoods delivered "ready to install", with all accessories included, such as light fitting, T.A.B.™ airflow measurement taps, and dampers for quick balancing on-site.
- Sturdier and easier to clean (less parts and fewer joints). Stainless steel construction.

(1) LEED - Leadership in Energy and Environmental Design (2) BREEAM - Building Research Establishment Environmental Assessment Method (3) DGNB - German Sustainable Building Council (4) RE2020 - French Environmental Regulation 2020 (5) NF EN 16282-2 Equipment for commercial kitchens - Components for ventilation in commercial kitchens - Part 2 : kitchen ventilation hoods - Design and safety requirements (6) HACCP - Hazard Analysis Critical Control Point



Capture Jet™ technology

◦ High capture efficiency ◦ Energy savings

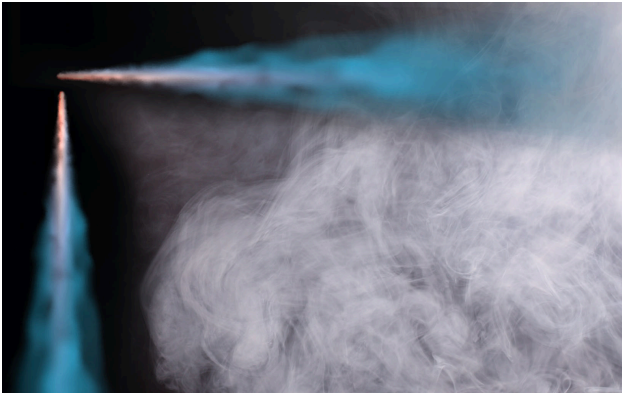

The *Capture Jet™* technology enables significant reductions in airflow rates leading to savings on construction costs, mainly due to the reduced size of ducts and HVAC equipment. It typically pays for itself upon the startup of the kitchen or within few months. The energy savings it generates then directly contribute to an increase in profitability, while the staff benefits from improved working conditions.

Benefits

- The *Capture Jet™ technology* allows for up to a 40% reduction in exhaust airflow rates.

- No specific duct required for the Capture Jets. In addition to the reduction of the ducts and HVAC systems size, it reduces installation cost and the CapEx.
- It generates important energy savings on cooling/heating the makeup air (less air out, less air in!).
- The reduction of the draft risk and noise levels improves the working conditions for the staff.

How does it work?

The Capture Jet™ technology is based on the use of one or several sets of aerodynamic nozzles, supplied with an extremely low airflow.

These nozzles form one or several air curtains. Carefully located and oriented, they prevent the grease, steam, smoke and heat etc. released by the cooking appliances from escaping and orient them toward the filters. It is this capture efficiency improvement that enables the ventilation volumes.

KCH hoods are equipped with dual nozzles on the front and sides.

Schlieren tests on a Halton hood with the Capture Jets ON and OFF



The Schlieren system shows the convective flows of cooking appliances so that the hoods' capture efficiency can be reliably and objectively measured.

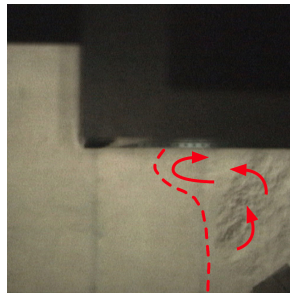

Capture Jets ON @3600 m³/h.
The convective flows do not escape on the hood front. They are efficiently extracted.

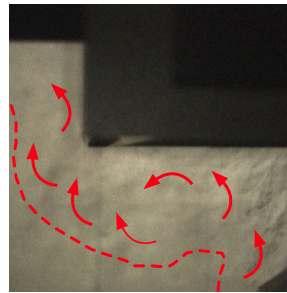

Capture Jets OFF @3600 m³/h.
With a traditional hood, a significant part of the convective flows escapes.

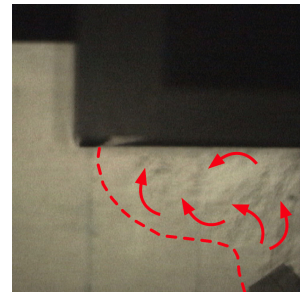

Capture Jets OFF @6000 m³/h.
With 2400 m³/h more airflow, a traditional hood captures again all convective flows.



KSA aerosol separator

◦ Cyclonic effect ◦ Reduced cleaning costs ◦ Improved safety



KSA cyclonic aerosol separators efficiency limits grease and particles deposition inside the exhaust plenums of Halton's hood and ventilated ceilings and in the ductwork. They are a cost effective solution to reduce the duct cleaning costs while directly contributing to a better hygiene and fire safety.

Benefits

- KSA cyclonic aerosol separators constructed of stainless steel in compliance with EN 16282-6. Up to 95% efficient on 10 microns particles or larger with a reasonable pressure loss of 120 Pa.

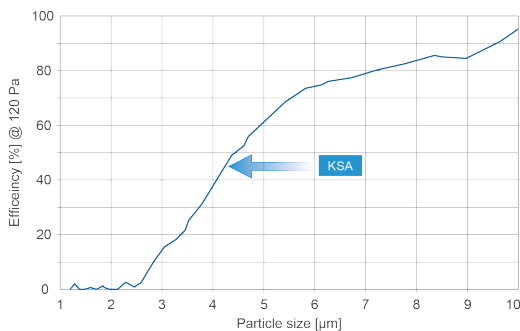

Tests on KSA aerosol separators' efficiency carried out on a Halton hood exhaust plenum by VTT laboratory, according to VDI 2052 (part 1).

- KSA separators' flame-behaviour also complies with UL 1046 and LPS 1263 standards. They also have NSF (National Sanitation Foundation) hygienic and safe approval.
- Improved hygiene and fire safety thanks to fewer grease deposits in the ducts.
- Lower maintenance costs due to reduced cleaning frequency.
- Reduced noise levels and fans' energy consumption thanks to the low pressure loss compared to baffle filters.
- Improves the performance of UV-C Capture Ray™ technology due to its high extraction rate.

How does it work?

KSA cyclonic filters are composed of vertical honeycomb profiles, opened only at top and bottom part. This design forces the air to swirl in a similar way as a cyclone when the air goes up and down inside to escape.

The centrifugal effect is impactful, and continuous – a mechanism that traditional baffle filters do not have. Particles are thus projected against the honeycomb walls, resulting in better separation performance.

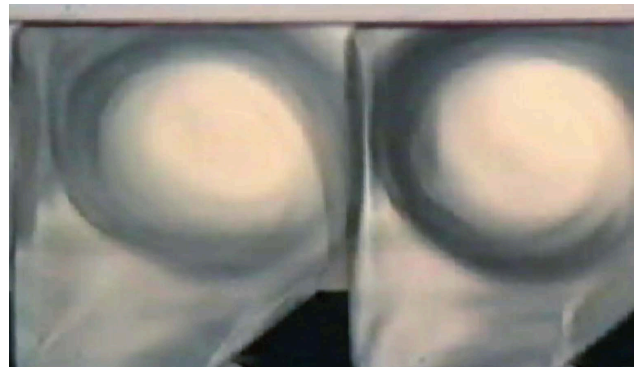

Visualization of the cyclonic effect inside the KSA aerosol separator's profiles (Schlieren test).



Halton Skyline

◦ Culinary and Human Centric light



Halton Skyline is the first LED lighting technology specifically developed for the needs of commercial kitchens, starting with staff's comfort. The light it provides is the closest possible to natural light thus offering many tangible benefits.

How does it work?

Halton Skyline is based on the use of two types of light sources, both equipped with the latest generation of highly efficient LEDs.

A broad beam spot (4000K - CRI of 83) - It is designed to provide a uniform and bright general lighting. For the most advanced Human Centric version, it is equipped with two sets of LEDs to make the color temperature varying from 2200 to 6500K. This enables creating daylight-similar sequences to offer lighting conditions that are Circadian rhythm-friendly, with

recognized biological and psychological benefits for the staff.

A focussed beam spot (2800K - CRI of 95) - It is used to further improve the lighting level and the color render of the food in strategic locations, above cutting machines or griddles for instance, or even the plating presentation area.

Halton Capture Jet™ hoods' light fittings are equipped with Halton Skyline broad beam spots (4000K colour temperature).

Benefits

- Very good illuminance levels and uniform light, with a good balance between the direct and diffuse components.
- Remarkably respects the natural food color and texture.
- Improved safety and best visual comfort, without alteration over time.
- Consumes up to 2,8 times less than fluorescent tubes while having a luminous efficacy of 120 lm/W.
- 50,000 hours lifetime for both the LEDs and the drivers.
- Saves the replacement of up to 125% of the fluorescent tubes, adding significant maintenance savings to the energy savings.

Integrated in Halton's suspended metal ceilings or thanks to standalone modules, Halton Skyline can be extended to the whole kitchen and beyond. It then opens the way to the most advanced and Human Centric lighting global solution.



Construction

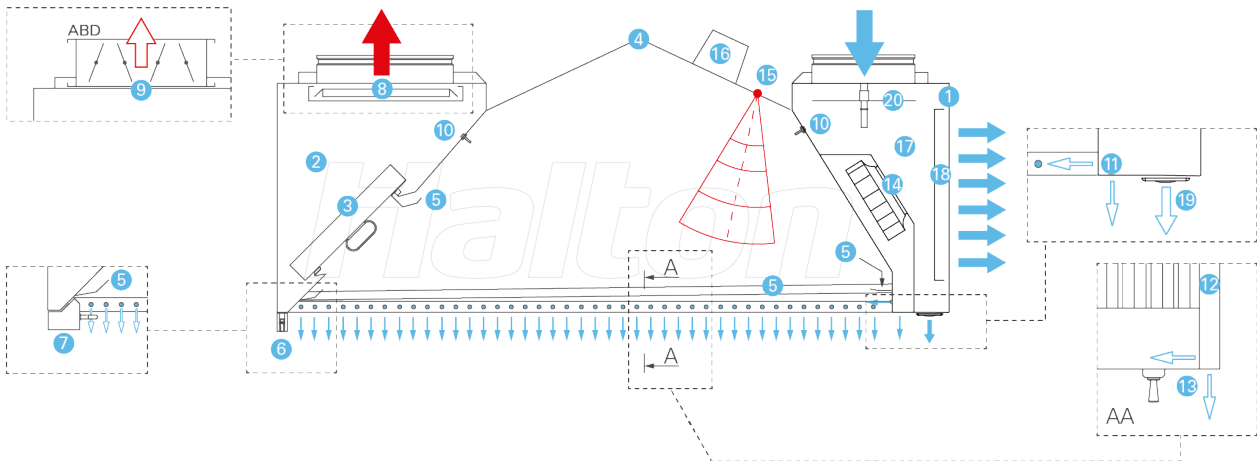

1. Visible outer envelope in stainless steel AISI 304 (1,0 mm).
2. Exhaust plenum.
3. KSA aerosol separators.
4. Special diamond-point shaped roof.
5. Perimeter gutter system.
6. Condensates drain.
7. Collection tray as an option.
8. Exhaust connection(s) and sliding damper(s).
9. When the kitchen is equipped with M.A.R.V.E.L. airflow and energy optimization technology (MRV), the sliding damper is replaced by ABD automated balancing slim damper.
10. T.A.B.™ (Testing And Balancing) pressure port(s) for quick airflow calculation during ductwork balancing operations.
11. Front Capture Jet™ nozzles.
12. Double skin sides.
13. Side Capture Jet™ nozzles.
14. Integrated Capture Jet™ fan.
15. Halton IRIS™ infrared sensor (used for the optional M.A.R.V.E.L. or FireWatch technologies). *
16. Halton Skyline LED culinary LED spots flush-mounted on the hood roof.
17. Makeup air plenum.
18. Perforated front face with honeycomb structure for a low velocity makeup air.
19. Personal supply air nozzles.
20. Supply air connection and adjustment damper (type MSM).

* M.A.R.V.E.L. or FireWatch options require controllers that are typically installed on the top of the light fittings.

M.A.R.V.E.L. ready option: To allow for later installation of M.A.R.V.E.L. airflow and energy optimization, each hood can be equipped only with its ABD slim automated balancing damper, which is typically very difficult to install afterward.

Dimensions

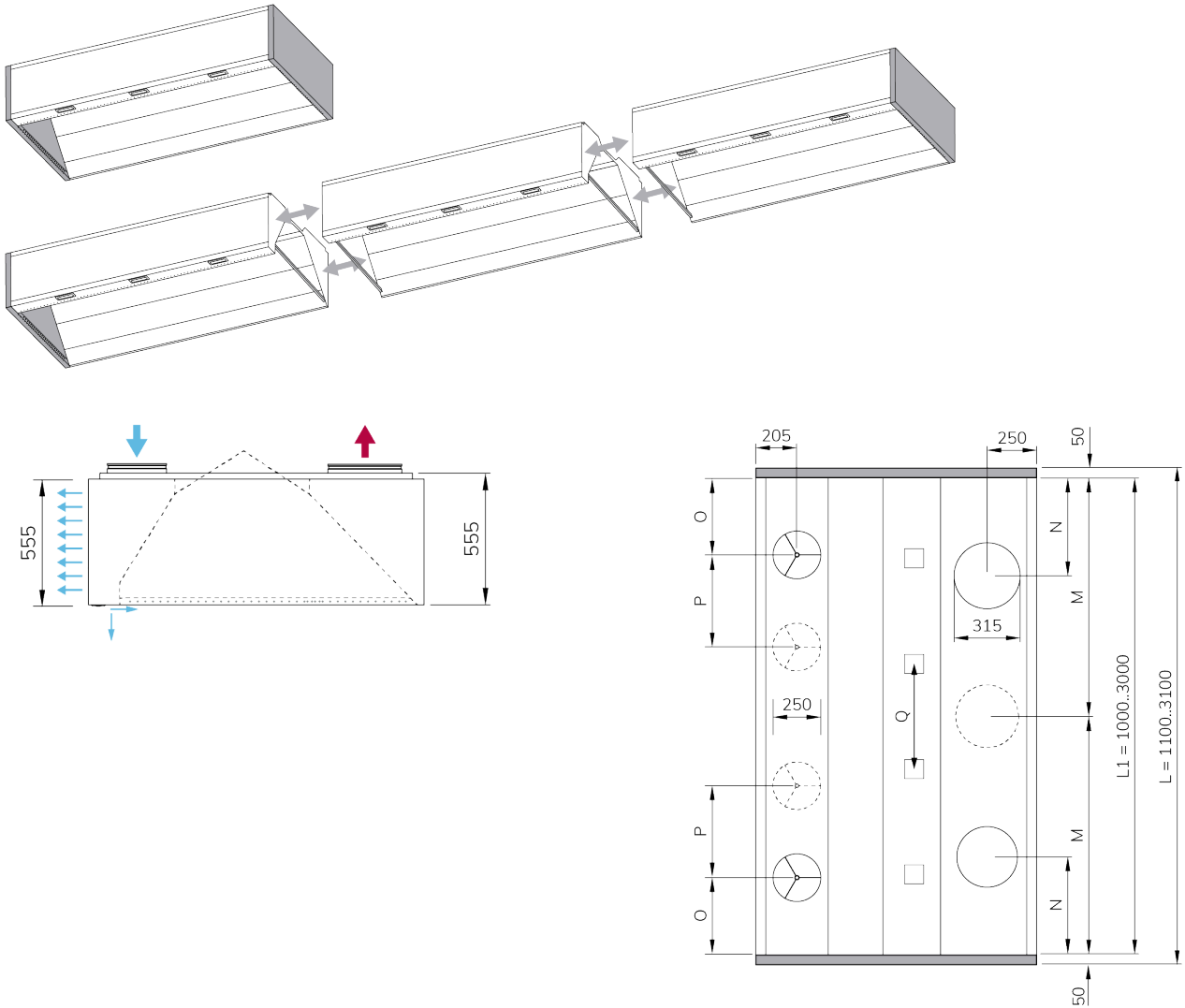

[mm]	1x	2x	3x	2x	4x	
L	M	N	M, N	O	O, P	Q
1100	L1/2	-	-	450	-	500
1600	L1/2	325	-	450	-	500
2100	L1/2	450	-	450	450, 500	500
2600	-	450	L1/2, 450	450	450, 500	500
3100	-	450	L1/2, 450	-	450, 500	500

- Above 3100 mm, hoods are an assembly of separate sections to make transportation and site handling easier.
- Number of connections to be determined based on the sections length and on the calculation of the airflow rates (depending on the cooking appliances).
- Rectangular connections on request.

Admissible and calculated airflows

Admissible airflows

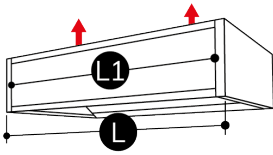

L [mm]	L1 [mm]	KSA [Nb]	↑ Q _E min..max ⁽¹⁾		↓ Q _S max ⁽¹⁾		↻ Q _{CJET} ⁽²⁾	
			[m³/h]	[l/s]	H=555	H=400	[m³/h]	[l/s]
1600	1500	3	1515...2358	420...654	200 l/s/m	157 l/s/m	97	27
2100	2000	4	2020...3144	560...872	720 m³/h/m	565 m³/h/m	112	31
2600	2500	5	2525...3930	700...1090	MSM @100%	MSM @100%	127	35
3100	3000	6	3050...4716	840...1308	ΔPst=48...52 Pa	ΔPst=45...70 Pa	142	39

(1) Q_E Min..Max/KSA = 505..786 m³/h | ΔP_{T,A,B} Min..Max = 50..120 Pa

(2) Side Jets with W=1300 mm

Calculated airflows

The calculated exhaust airflow rates are determined with a EN 16282-1 based calculation method. It relies on the evaluation of the convective flows' volume (air mixed with heat, steam, grease, smoke and other pollutants) generated by the cooking appliances, depending on their type, on the energy they use and their installation conditions (central, on a wall, in an angle).

The air volume required to remove the convective loads is then calculated depending on:

- The hood or ventilated ceiling installation height;
- The makeup-air strategy (mixing or displacement);
- The hood or ventilated ceiling capture efficiency according to ASTM 1704-12 standard.

KCH-F hood reduces the exhaust airflow rates⁽¹⁾ by up to 40% compared to traditional hoods.

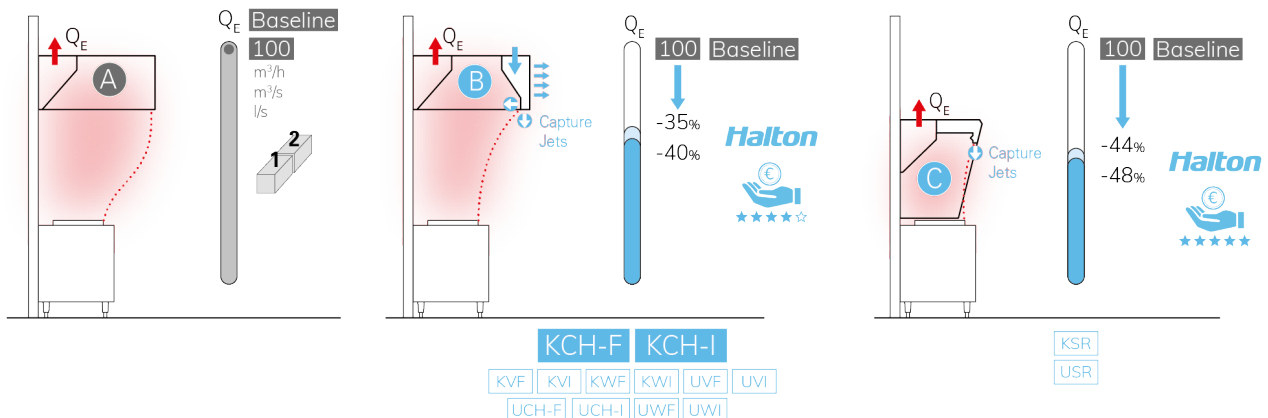

(1) This scale is indicative and based on wall mounted hoods, opened on 3 sides, equipped with a same cooking bloc, whatever it is. The variation in exhaust airflow reduction for a given hood type is due to the makeup-air type (mixing or displacement). Other parameters do impact the final airflow rates. Our sales teams are at your disposal to provide you with a calculation note, depending on your kitchen configuration.

Green Steel label



Manufactured with decarbonized stainless steel (option)

Halton's innovations are recognized for significantly improving its customers' carbon footprint from day one of operation. However, sustainability and low environmental impact require manufacturing these solutions with the lowest possible carbon footprint.

As of the second half of 2024, and initially for Europe, Halton progressively offers the possibility to manufacture its Capture Jet™ hoods with decarbonized stainless steel as an option.

CO₂ emissions reduced by 60%! This is the carbon footprint average reduction achieved for this green steel, with the same mechanical properties. Per ton, it represents 850 kg CO₂ less or the equivalent of 4595 km with a thermal car, 5600 km for a medium-haul plane or 423636 km with the French fast train, powered with decarbonized electricity (1).

(1) According to the ADEME ([The French Agency for Ecological Transition](#)) resource site which popularizes and promotes environmental data.

Pressure losses and sound levels (exhaust)

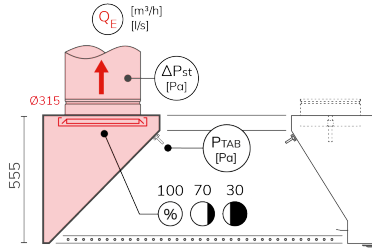
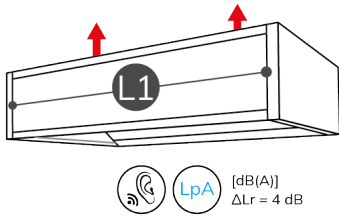

L1 = 1000 mm

2 KSA

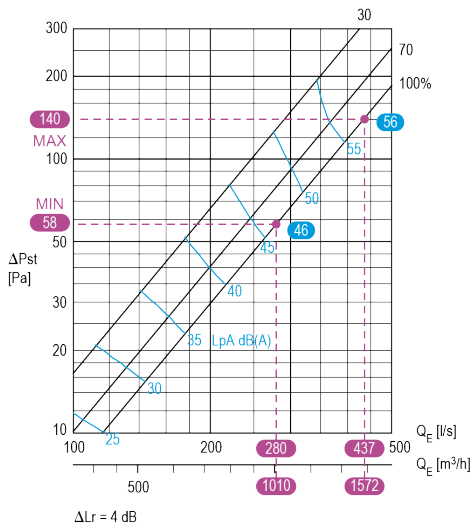

L1 = 1500 mm

3 KSA

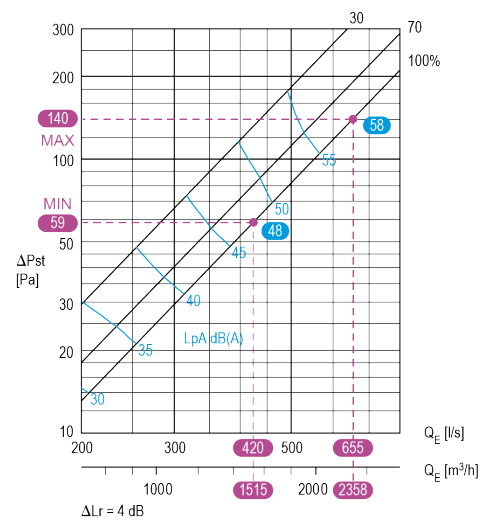

L1 = 2000 mm

4 KSA

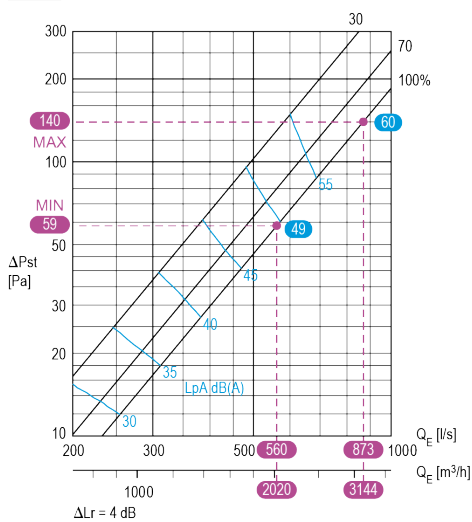

L1 = 2500 mm

5 KSA

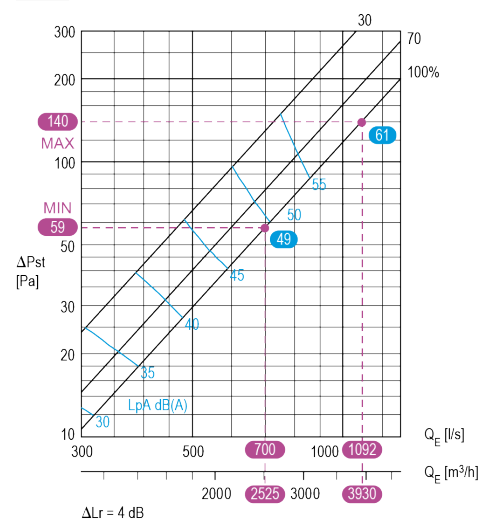

L1 = 3000 mm

6 KSA

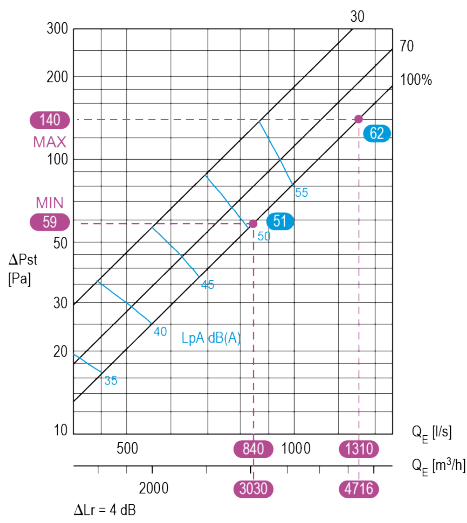

Airflow measurement (T.A.B.™ reading or use of hood k factor)

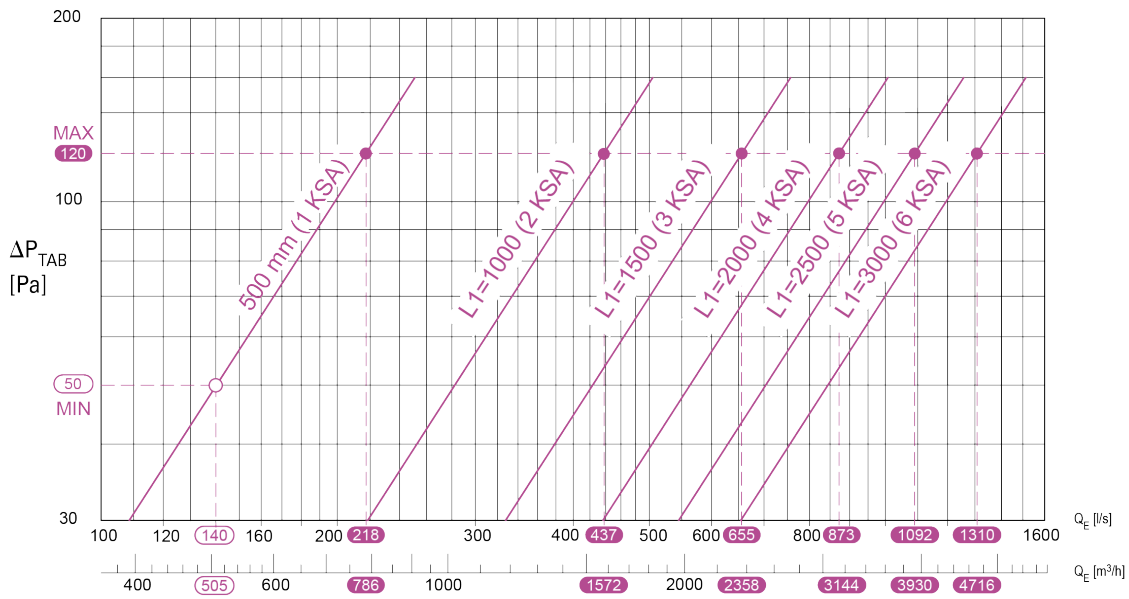

$$Q_E = k \times \sqrt{P_{TAB}}$$

$$Q_E = k \times \sqrt{P_{TAB}} \text{ [Pa]}$$

KSA	k [m ³ /h]	k [l/s]
1	71,8	19,9
2	143,6	39,8
3	215,4	59,7
4	287,2	79,6
5	359	99,5
6	430,8	119,4

Pressure losses and sound levels (supply)

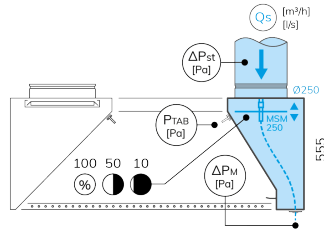
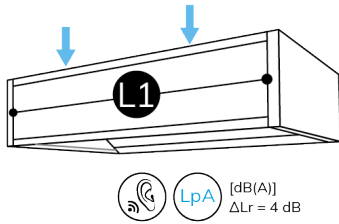

L1 = 1000 mm

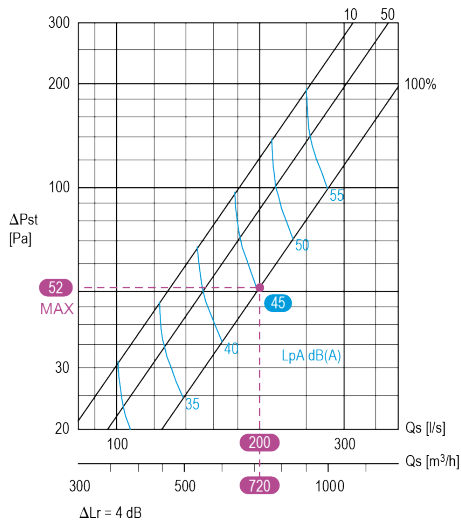

L1 = 1500 mm

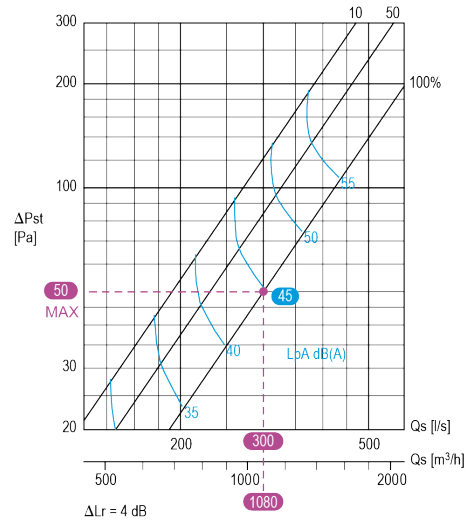

L1 = 2000 mm

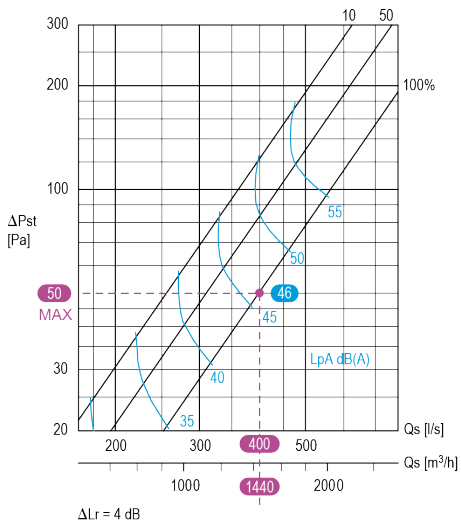

L1 = 2500 mm

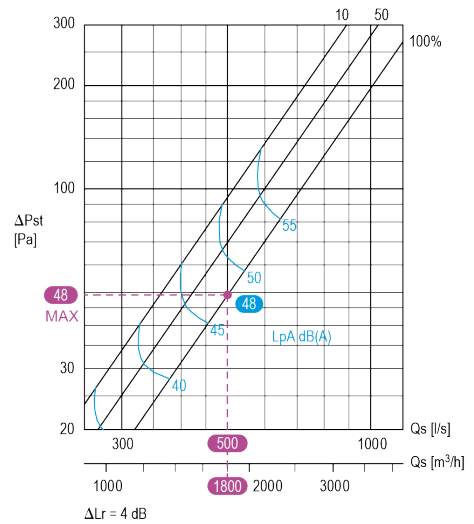

L1 = 3000 mm

ΔP_{st} $L_p A$ f Q_s %

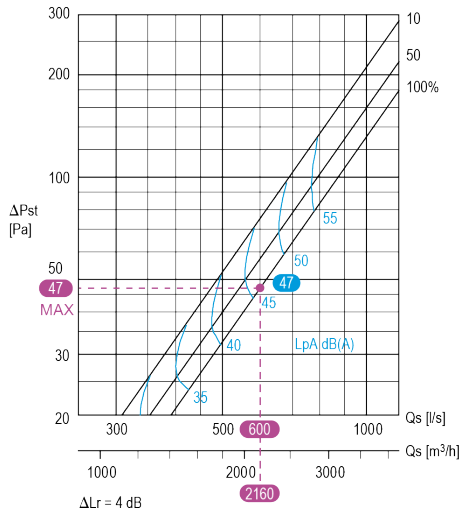

Airflow measurement (T.A.B.™ reading or use of hood/MSM k factor)

Q_s f P_{TAB} $L1$

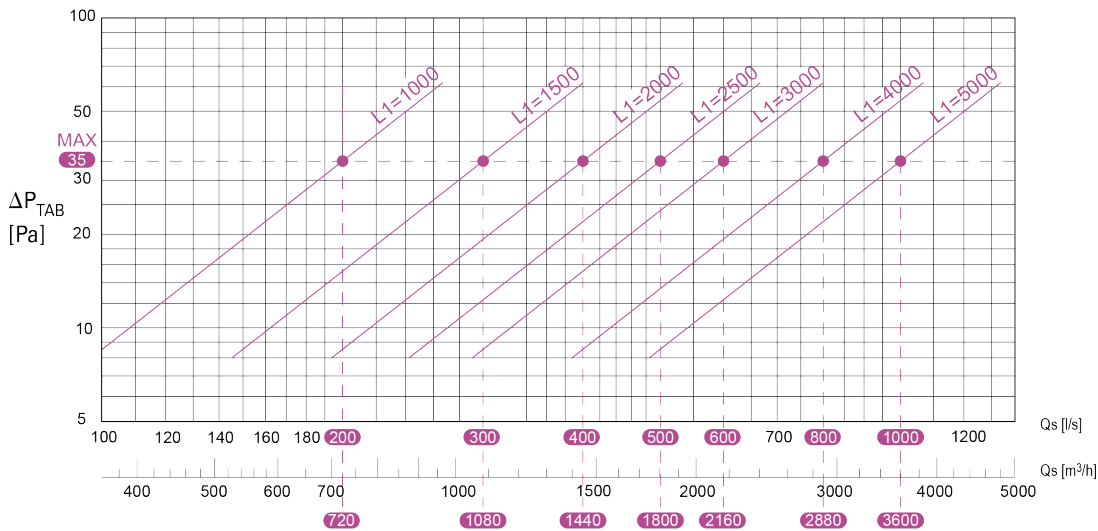

Q_s f P_{TAB} $L1$

$$Q_s = k \times \sqrt{P_{TAB}} \text{ [Pa]}$$

L1 [mm]	k [m³/h]	k [l/s]
1000	121,7	33,8
1500	182,6	50,7
2000	243,4	67,6
2500	304,2	84,5
3000	365,1	101,4

Or Q_s f ΔP_M $\frac{2..4}{MSM}$

MSM250

$$Q_s = \sum Q_s \text{ (MSM 2..4)}$$

$$Q_s \text{ (MSM 2..4) [l/s]} = 51 \times \sqrt{\Delta P_M \text{ [Pa]}}$$

$$Q_s \text{ (MSM 2..4) [m³/h]} = 183,6 \times \sqrt{\Delta P_M \text{ [Pa]}}$$

Suggested specifications

KCH-F / KCH-I

The hoods shall be Halton brand - range KCH-F / KCH-I.

- KCH-I is the extract-only model.
- KCH-F is equipped with an integrated makeup air system on the front.

The hoods shall be supplied ready to be installed. All technologies and systems shall be delivered fully pre-wired.

The following specifications shall be fully observed.

Capture Jet™ technology

- The Capture Jet™ technology is based on the use of sets of aerodynamic blowing nozzles. Each set forms an air curtain that is used to increase the capture and containment efficiency on smoke, steam and heat.
- The exhaust airflow rates shall thus be reduced by up to % while removing the same heat, steam and smoke load compared to traditional systems.
- The nozzles shall be designed to get a high air speed at output while not creating draughts that could have an opposite effect to that expected. They shall not represent more than 5% of the calculated exhaust airflow rates.
- The Capture Jets shall be fed with an integrated fan, in order to provide the airflow and static pressure required for an optimal efficiency. A specific ductwork is thus not required.
- [Option] The Capture Jet™ fans shall be controlled by a pressure switch to stop it when the kitchen exhaust is off or at minimum speed.

Exhaust airflow rates

- The exhaust airflow rates shall be determined with an EN 16282-1⁽¹⁾ based calculation method. Hence, they shall take into account:
 1. the convective loads released by the cooking appliances, whether they are characterised by the EN 16282-1, the manufacturer or a third party;
 2. the type and installation configuration of the exhaust device(s).
- The calculation method shall, in addition, consider the capture efficiency of the exhaust devices according to ASTM 1704 standard.
- Both the exhaust airflow rates, and capture efficiency shall be justified by a calculation note.
- Any modification of the exhaust devices' installation height or of the input power, type and dimensions of the cooking appliances shall be brought to the attention of the manufacturer as they all significantly impact the exhaust airflow rates.

Makeup air design

- The makeup air design, especially the diffusers type, size, and location as well as the means to get a correct balance between exhaust and supply, shall be entrusted to the manufacturer. It impacts the exhaust airflow rates, the capture efficiency and is also key to preventing cross-contaminations.
- The makeup air shall be as much as possible managed by way of the diffusers integrated in the hoods' front. If their capacity does not cover the total needs of the kitchen, the additional diffusers shall be of laminar-flow type.

Outer casing and general

- The construction shall be compliant with NF EN 16282-2.
- The hood's roof shall have a diamond-point shape to facilitate the drainage of condensation droplets toward a gutter system.
- The gutter system shall be installed on the four sides of the lower part of the hood's containment volume, with an additional gutter above the exhaust plenum's aerosol separators. All gutters shall be connected to the hood's exhaust plenum to evacuate the condensation.
- Constructed from 1.0 mm AISI 304 (DIN EN 1.4301) stainless steel, with a 320 grit on the visible side.
- The joints of the lower edges shall be fully welded for better robustness, cleanability and a better aesthetic.
- All exposed welds are ground and polished to the metal's original finish.
- Sides shall be double-skin.

Exhaust plenums

- Constructed from 1.0 mm AISI 304 (DIN EN 1.4301) stainless steel, with a 320 grit on the visible side.
- The lower part of the plenum's sides shall be welded for a durable tightness to condensates.
- The aerodynamic shape of the plenums' bottom part shall help the smoke and steam freely rising up without stagnating. This contributes to prevent the build-up of condensation drips that risk falling down on the cooking appliances.
- The exhaust plenums shall be equipped with KSA cyclonic aerosol separators. Their efficiency shall be at least 95% on 10 microns particles or larger, as tested by an independent laboratory. Constructed from stainless steel, they shall comply with EN 16282-6. They shall also be certified UL 1046, NSF and LPS 1263.
- The plenum shall be equipped with a T.A.B.™ (Testing And Balancing) pressure tap for quick airflow measurement.

[Option] Airflow optimization technology

- The exhaust hoods shall be equipped with an airflow optimization technology. It shall be Halton Brand, MRV (M.A.R.V.E.L.) model.
- The optimization technology shall automatically adjust the exhaust airflow rates, depending on the cooking activity, in real time and independently. If only one cooking zone is operating, only the airflow required for that zone would be automatically adjusted. The other zones shall continue to operate at a low flow rate.
- The control system shall be part of Halton Connect IoT (Internet of Things) control platform.
- Refer to the specific description.

[KCH-F] Integrated makeup air

- The hoods shall be equipped with an integrated low-velocity diffuser on the front for the make-up air.
- The diffusers' plenum shall be equipped with dampers of MSM type used to adjust the supply airflow and also to get a uniform distribution of the air inside the plenum. The air shall be then streamlined by the mean of a "honeycomb" structure and the perforated facade.
- The facade and honeycomb structure shall be easy to remove for cleaning and maintenance operations.
- The internal face of the plenums shall be insulated to avoid any risk of condensation on the containment volume side.
- The plenum shall be equipped with a T.A.B.™ (Testing And Balancing) pressure tap for quick airflow measurement.

Light fittings

- The hoods shall be equipped with Halton Skyline LED wide-beam spotlights, glued flush-mounted on the diamond-point ceiling.
- The illuminance on the working surfaces shall be at least 500 lx.
- The spots shall provide a uniform light, with good balance between the direct and diffuse components, to make forms and textures clearer and richer in contrast without dazzling the staff.
- The spots' shielding angle shall exceed the specification of EN 12464-1 and be greater than 30° while its Unified Glare Rating (UGR) shall be lower than 19.
- They shall have a color temperature of 4000K and a Color Rendering Index (CRI) of at least 83.
- The LEDs and drivers lifetime shall be at least 50,000 hours. The drivers shall be DALI compatible. The spots' efficiency shall be at least of 105 lm/W.

- The spots shall be closed by a seamlessly glued safety glass plate for a better hygiene and ease of cleaning. Its protection against water spraying shall be IP54. The glass shall be fire-rated A1 i.e. non-flammable according to EN 13501-1.
- As standard, the power supplies shall enable switching on/off or dim the light (1-100%) with one or several switches.
- **[Option]** A specific DALI user interface, with scenario and zoning functions, shall be used to control the light fittings.

[Option] Fire prevention Halton FireWatch

- The system shall be equipped with Halton FireWatch prevention technology
- Based on Halton Thermal Imaging (HTI) sensor, it shall continually monitor the variations in surface temperature for the cooking appliances and the temperature in the exhaust plenum to detect abnormalities that are a precursor to a fire event.
- The system shall alert the user of conditions that increase the likelihood of on a Halton Touch Screen that shall also recommend to take action before the the shutdown of equipment or discharge of the fire suppression system.
- The alarm shall be relayed with an external visual and/or sound indicator.

[Option] Fire Suppression System

- The fire extinguishing system shall be the Ansul® R-102™ or Piranha type.
- It shall be pre-installed from the factory for better integration.
- The detection chain and fusible link(s) shall be fully integrated inside the exhaust plenums to not be visible.
- The nozzles and pipework used inside the exhaust plenums, at the connections to the ductwork and above the cooking appliances shall not block or obstruct any of the extract devices' components neither interfering with their operation, whether during commissioning or maintenance.
- Unless technically impossible, no horizontal pipework shall be visible inside the containment volume of the extract devices or run along the exhaust plenums. The nozzles shall drop directly from the top of the exhaust devices equipped.
- The commissioning shall be carried out by the hood manufacturer or a certified partner. In all cases, it shall be an authorised representative of Ansul, and the installation shall comply with UL 300 requirements and local codes.

(1) The European Standards published by CEN are developed by experts, established by consensus and adopted by the Members of CEN. It is important to note that the use of standards is voluntary, and so there is no legal obligation to apply them (source: CEN).

halton.com

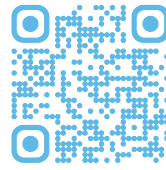
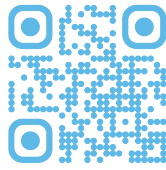

Halton Manufacturing and Sales Facilities in the world

 Sales and service centers

 Representatives

 Factories

 Manufacturing licences

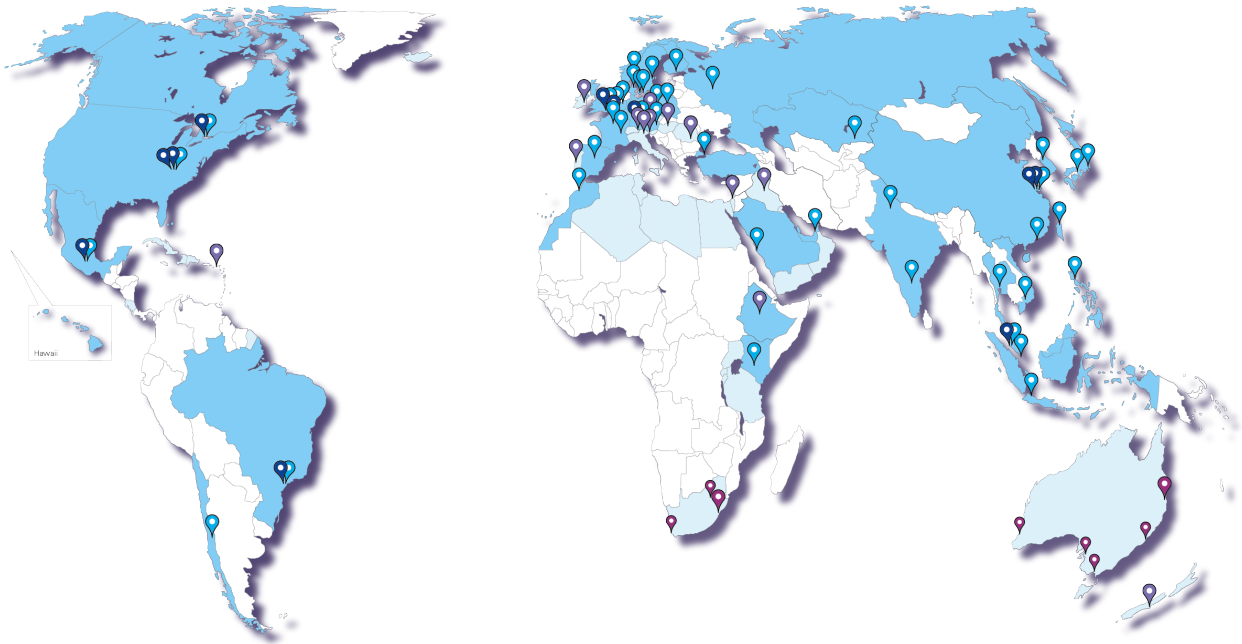

Halton Foodservice partnerships

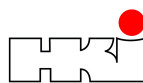

Halton has a policy of continuous product development, therefore we reserve the right to modify design and specifications without notice. For more information, please contact your nearest Halton agency. All rights reserved. No part of this publication may be reproduced, distributed, or transmitted in any form or by any means, including photocopying, recording, or other electronic or mechanical methods, without the prior written permission of the publisher, except in the case of brief quotations embodied in critical reviews and certain other non commercial uses permitted by copyright law.