

USR-S / USR-S-OD / USR-F / USR-F-OD

Capture Jet™ backshelf (S) or freestanding (F) hood for electric fryers or griddles
With Capture Ray™ technology / UV On Demand option (OD) / M.A.R.V.E.L. compatible



USR hoods are suitable for LEED⁽¹⁾ projects and can be used in open or closed kitchens, particularly the Quick Service Restaurants located in dense urban areas or whose ducts are difficult to access. They are designed to capture pollutants generated by electric fryers and griddles more efficiently as they are located closer to the cooking appliances.

USR hoods are equipped with the UV Capture Ray™ technology that neutralises the grease carried by the exhausted air. By carefully selecting the number of UV lamps, airborne cooking odours will be so minimal that it can negate the need to discharge the vitiated air at high level from the building. Eliminate neighbourhood and safety concerns, establish your restaurant wherever you choose, and save a great deal on your energy bill and cleaning costs.

USR hoods are also equipped with the Capture Jet™ technology.

The free standing model USR-F is also equipped with side Capture Jets to enable a large opening on the sides. This model also has a services distribution unit on its back.

- Minimum space used.
- Considerable energy savings: Up to 50% reduction in exhaust airflow rates thanks to front Capture Jets.
- Savings on maintenance and enhanced safety: Two-level filtering with highly-efficient KSA cyclonic filters (UL, NSF and LPS 1263 certified). Neutralisation of remaining grease particles and vapours due to Capture Ray™ technology.
- The drastic reduction of the grease deposits lowers the cleaning costs for ductwork and exhaust plenums and

raises hygiene and fire safety to the highest level.

- The Capture Ray™ technology also reduces drastically the odour emissions.
- Secure access to the UV-C lamps and CE-certified plug & play control system with LCD touch screen (Halton Touch Screen).
- **USR-S-OD USR-F-OD** -The UV On Demand option activates the lamps only when cooking appliances are actually used and saves up to one lamps set where other UV systems require two.
- Halton Skyline LED culinary light provides the best visual comfort while contributing to further improve the safety and the energy savings.
- Performance tested independently in accordance with the ASTM 1704 standard. Exhaust airflow rates calculated on the basis of this performance and the calculation of cooking appliances' heat loads.

USR-F USR-F-OD Freestanding models

- Integrated self-supporting structure.
- Combination of front Capture Jets and side(s) driving Jets allowing a large opening of one or both sides for the passing of the fries baskets.
- Services distribution on the back of the hood equipped with the electric plugs for the fryers/griddles.

(1) Leadership in Energy and Environmental Design

Description of the main technologies

USR-S
USR-S-OD



USR-F
USR-F-OD



New version

The optional UV on Demand technology extends UV lamps lifetime

Halton Skyline LED Culinary light inside



Lower side Jets
combined with the Capture Jet™ technology (USR-F and F-OD)



Capture Jet™ technology
Up to 50% reduction in airflow rates



Cyclonic filter (KSA)
95% efficient on 10 µm and above particles



UV-C Capture Ray™
Neutralises grease vapours and particles



UV On Demand
UV lamps activated only when needed (USR-S-OD and USR-F-OD) **Option**



Halton Touch Screen (HTS)
Unique and intuitive LCD user interface for all systems **Option**



Halton Skyline (HCL)
Kitchen specific and LED based Culinary Light



Testing & Balancing (T.A.B.™)
Quick airflow rates measurement



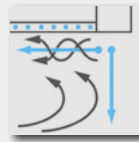

Side Jets and Capture Jet™ technology

ENERGY EFFICIENCY

40 to 50% reduction in exhaust airflow rates.

INDOOR ENVIRONMENT QUALITY (IEQ)

The capture efficiency combined with reduced airflow rates improve the working conditions.

SAFETY

Cooking vapours are not dispersed and food safety is improved.

Capture Jet™ technology

The Capture Jet™ technology consists of one set of vertical nozzles located on the front of the hood. These nozzles form a curtain which increases the containment volume and prevents vapours escaping from cooking areas.

The bottom edge of the exhaust plenum is aerodynamically designed to not disturb the rising up of the thermal plumes, thus further improving the Capture Jets action.

The absence of spillage lead to a better indoor air quality and to minimal heat load transmission to the kitchen. The exhaust airflow rate leads to huge energy savings while limiting the risk of drafts and facilitating the temperature regulation.

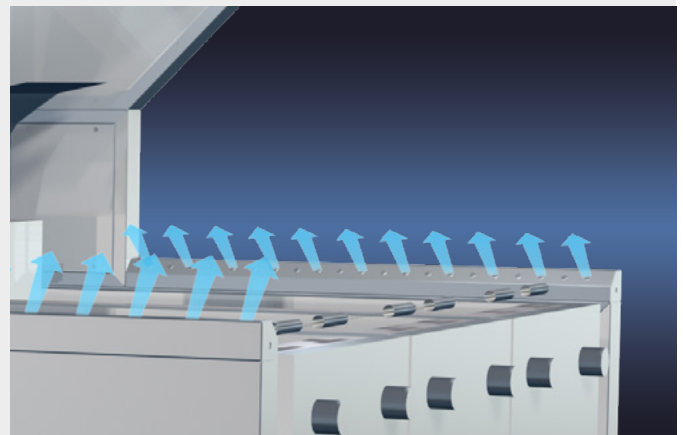

Combination with Side Jets (freestanding model only)

- Enables a large opening of the sides of the hood hence providing a large passing for the fryers baskets
- Better ergonomic and working conditions without compromising the capture efficiency

The Side Capture Jets consist of a set of inclined nozzles, at the level of the cooking surfaces, on both the right and left sides of the cooking appliances block. They allow a large opening of the hood sides hence providing a large passing for the fryers baskets.

The nozzles have been designed to create an air curtain able to gently push the smoke toward the exhaust plenum without dispersing them.

The Side Jets modules are removable without tool for a total ease of cleaning.

Numeric Simulation (CFD) on a backshelf hood with and without front Capture Jets

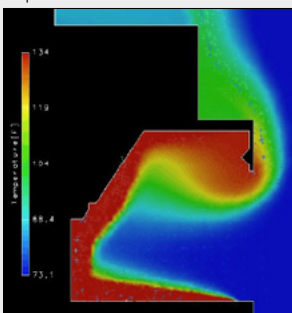

WITHOUT Capture Jets, heat spilling on the front of the hood

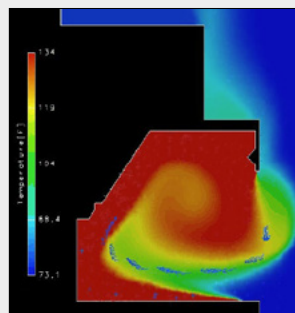

WITH Capture Jets, total Capture & containment of the smoke

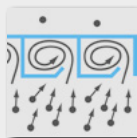

Highly-efficient KSA cyclonic filters

ENERGY EFFICIENCY

Reduces the energy used by fans, by minimising loss of pressure.

SAFETY

95% efficiency on 10 µm particles minimises build-up of grease deposits and improves fire safety and food safety.

KSA cyclonic filters are composed of vertical honeycomb sections. Opening only at the top and bottom, they are designed to force the air to swirl inside. The centrifugal effect is significant and, above all, continuous – especially in comparison to the action of traditional filters. Particles are thus thrown against the honeycomb walls with much higher force. KSA filters are **95% efficient on 10 µm particles.**

- Improved hygiene and fire safety thanks to less grease deposits in the exhaust plenums and ducts.
- Lower maintenance costs due to lower cleaning frequency.
- Improved noise levels thanks to limited pressure loss.
- A must for the use of UV-C Capture Ray™ technology.
- Unbeatable Efficiency/Pressure loss ratio.

KSA filters are accredited by the UL (Underwriter Laboratories) as flame-retardant and have NSF (National Sanitation Foundation) Hygienic and safety approval. They are fitted on all hoods and ventilated ceilings.



Schlieren tests on a KSA filter

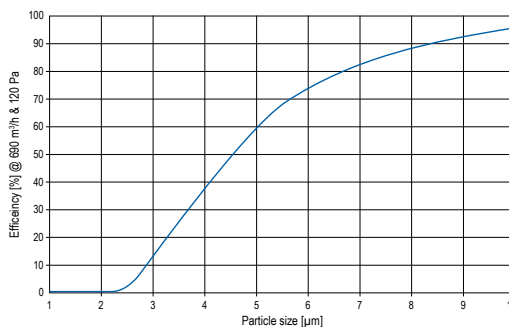

Tests carried out by VTT according to VDI 2052 (part 1) "Ventilation Equipment for kitchens. Determination of Capture Efficiency of Aerosol Separators in Kitchen Exhaust"

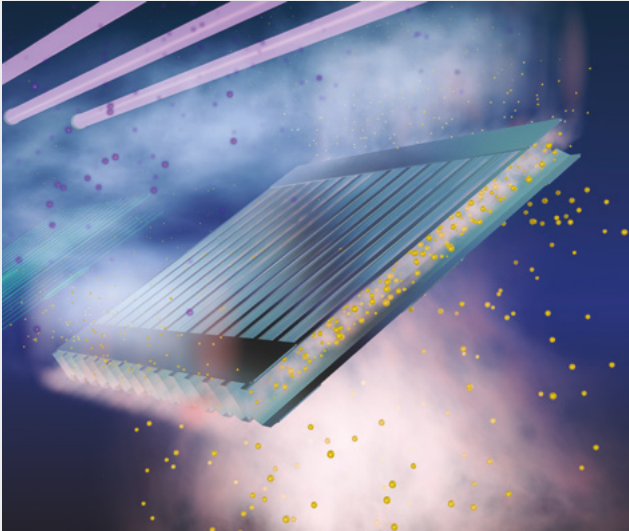

UV-C Capture Ray™ technology

SAFETY

Minimises grease deposits in ducts. Improved hygiene and maximum fire safety.

CONTROLLED EMISSIONS

Odours are drastically reduced at the point of discharge.

ECONOMIC ADVANTAGE

Significant maintenance savings. Facilitates heat recovery. Negates the need to discharge at roof level.

UV-C Capture Ray™ technology is designed to neutralise grease particles, grease vapours and organic compounds which are not retained by the primary filtering system, despite its efficiency. By increasing the number of UV-C lamps to a carefully determined level, the odours conveyed through the air become so weak that it may no longer even be necessary to discharge air at roof level.

Capture Ray™ technology is based on the use of UV-C lamps. Neutralisation of grease particles, grease vapours and odours depends on two simultaneous phenomena. Photolysis is the direct effect of UV-C radiation. It works by photodecomposition whereby grease molecules are broken down by photons. Ozonolysis is the oxidation of grease molecules by ozone that is generated by the lamps. As ozone is a gas, it is carried with the airflow. Oxidation therefore takes place in the exhaust plenum as well as in the ductwork.

- The ductwork is kept clean:
 - Cleaning operations may be less frequent;
 - Fire safety and hygiene of the ductwork are maintained;
- Grease carried by the air is brought to so low a level that it makes heat recovery constant and efficient over time with the lowest maintenance cost.
- The emission of odours at the point of discharge is controlled. The neighbourhood is respected.

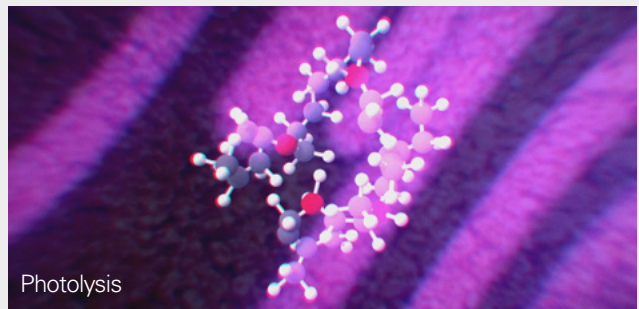

Photolysis

Photolysis is photodecomposition whereby grease molecules are broken down chemically by photons.

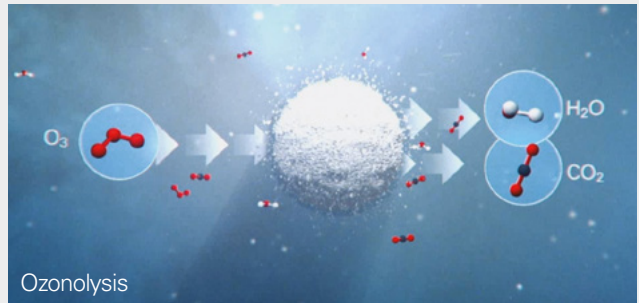

Ozonolysis

Ozonolysis is the oxidation of volatile organic components (VOC) and some of the odours by ozone.



View inside an exhaust plenum fitted with UV-C lamps after several weeks of use.

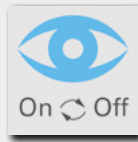

« UV On Demand » technology

ECONOMIC ADVANTAGE

Up to 44% average reduction in UV lamps operational hours. Energy savings adds to the maintenance costs reduction.

CONTROLLED EMISSIONS

Odours are still drastically reduced at the point of discharge when cooking appliances are in use. When they are not, the levels of excess ozone are reduced where it is not practical to combine the UV Hoods with a Halton PolluStop.

Halton developed a technology that monitors, in real time, the cooking appliances activity, thus activating the UV lamps only when it is strictly required.

This technology is based on Halton's IRIS sensor (Infrared Radiation Index Sensor). Also used for M.A.R.V.E.L. Demand Controlled Ventilation system, it scans the surface of the cooking appliances to monitor, in real time, the cooking appliances activity. This enables activating the UV lamps accordingly i.e. only in cooking mode and not continuously, as soon as the fan is switched on.

This is a safe and responsible approach that saves on lot on the UV lamps lifetime, thus reducing the maintenance costs while also saving energy.

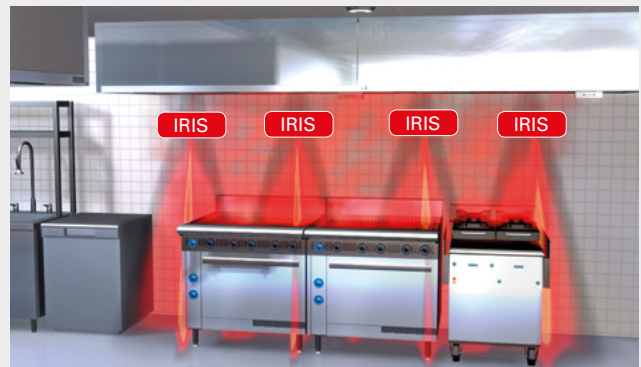

This option becomes standard when the hoods are equipped with M.A.R.V.E.L. technology.



44% average reduction in operational hours and 1403€ savings on electricity on only two hood sections installed at Shake Shack restaurant, central London.

This restaurant is equipped with two UVF hood sections (Capture Jet™ combined with the Capture Ray™ technology) and a PEU PolluStop unit. Both hoods are equipped with a 6 long lamps UV rack.

The cooking block comprises two griddles, 2 fryers and a fry scuttle for a total electric power of 50 kW. The restaurant operates 88 hours a week.

The UV lamps operation has been monitored over 4 weeks.

- The UV on Demand technology showed an average reduction in operational hours of 44% (up to 50% depending on cooking appliances use). UV on Demand saves up to one lamps set where other UV systems require two.
- The energy consumption reduction equals to 103 kWh per week which means 1403€ a year (0,26€/kWh).



Halton Touch Screen (HTS)

SAFETY

Users can easily control ventilation equipment, thus reducing the risk of misuse or unwanted stoppages.

MAINTENANCE

Preventative or curative maintenance operations are easier to organise.

The Halton Touch Screen is part of the Foodservice Control Platform, designed by Halton for Halton products. Each component is designed for targeted functions in order to fully and simply meet the particular requirements of all the solutions of the Halton High Performance Kitchen concept.

- The Halton Touch Screen is based on the use of clear diagrams.
- Information or alarms can be explicitly positioned on products or informative screens.
- This makes information easy to read and interpret, even by personnel with little knowledge of ventilation systems.

- It makes commissioning of installations quicker and simpler.
- In the event of a fault, the cause is quicker to find and any preventative or curative maintenance operations are easier to organise.
- The Touch Screen can be monitored remotely. It can also supply the Halton F.O.R.M.* platform with detailed information on the working order of equipment.

Your Kitchen Ventilation at your fingertips!

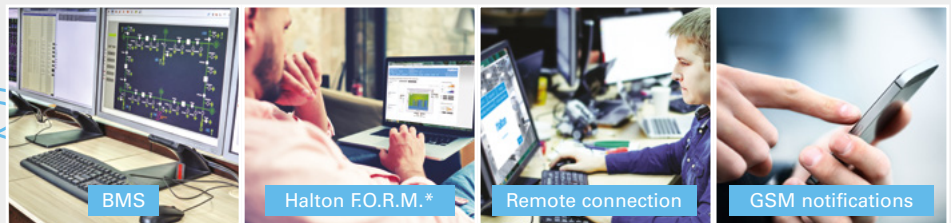

* Facilities Optimization and Resource Management

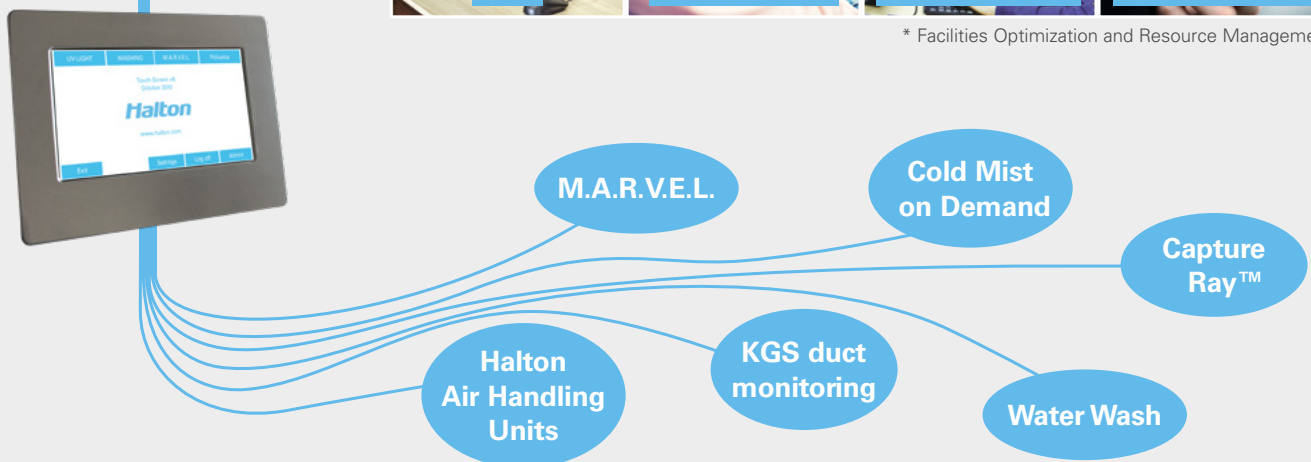



Culinary and Human Centric Light (Halton Skyline)

INDOOR ENVIRONMENT QUALITY (IEQ)

Close to sunlight render and increased lighting levels for a better colour and texture render. Ideal working conditions.

SAFETY

The sensible areas of the kitchen benefit from a better light for a better safety and quality control.

ECONOMIC ADVANTAGE

Drastic energy savings leading to reduced payback times.

The impact of lighting in professional kitchens has often been regulated to simply satisfying illumination levels without regard for personnel wellbeing.

The link between good lighting, better working conditions and productivity, is now widely recognized. However, what often occurs when a kitchen benefits from excellent lighting levels, the staff is dazzled from reflected light. When dazzling does not occur, the kitchen typically suffers from a lack of illumination that is more harmful for the

safety of the staff and hygiene of the kitchen.

Halton Skyline is the first LED based lighting technology specifically developed for professional kitchens. Everyone agrees the light it provides is simply the closest possible to natural light.

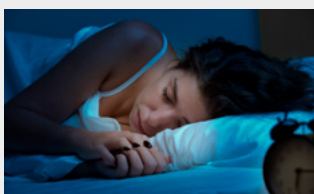
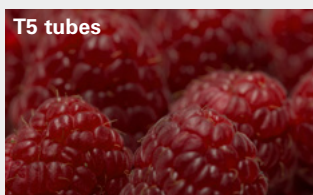

- Halton Skyline remarkably respects the food colour and texture from raw ingredients to plated presentation. The two spot models developed for Halton Skyline have respectively a CRI of 83 (@4000K) and 95 (@2800K).
- Halton Skyline provides the best visual comfort, without alteration over time and without dazzling the staff, thus also playing an active role in the kitchen safety. Among others, Halton Skyline's shielding angle is up to two times higher than DIN EN 12464-1⁽¹⁾ demand.
- Halton Skyline's Human Centric version is a biodynamic lighting centered on users needs. It creates daylight-similar sequences depending on the kitchen activity, further improving their working conditions and Wellbeing. You would think you were outside!
- A state of the art lighting technology that, at its core, saves significantly on energy and maintenance. With a luminous efficacy of 120 lm/W, Halton Skyline consumes up to 2,8 times less than fluorescent tubes.

Recommended combinations



M.A.R.V.E.L. Demand Controlled Ventilation (MRV)

ENERGY EFFICIENCY

Up to 64% reduction in exhaust airflow rates in association with Capture Jets. Reduces drastically the cooling/heating energy consumption and the energy use of supply and extract fans.

INDOOR ENVIRONMENT QUALITY (IEQ)

Reduces noise and draughts through constantly modulating air flows to the correct level to evacuate all vapours.

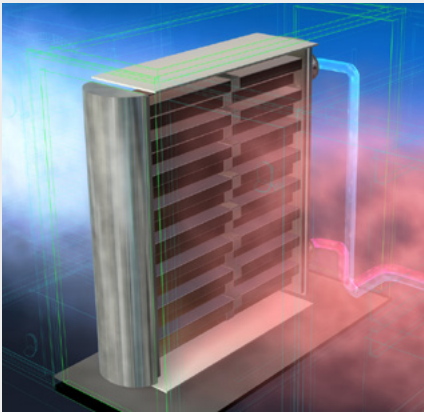

Halton exhaust and supply Air Handling Units with heat recovery

ENERGY EFFICIENCY

The drastic reduction of the grease quantity carried by air makes the heat recovery stable over time and really cost effective. Further increase your savings!

INDOOR & OUTDOOR ENVIRONMENT QUALITY

Benefit from the healthiest replacement air and establish your kitchen wherever you chose without fearing the neighbourhood complaints.

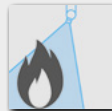
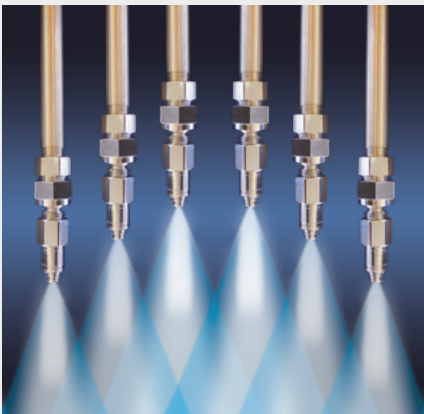

Built-in Fire Suppression System (FSS)

SAFETY

The kitchen and the rest of the building are protected by fires being extinguished at source. Plenums and exhaust connections are also protected from the spread of fire.

ECONOMIC ADVANTAGE

Integration of the system in the factory to provide better respect for products and to optimise costs.

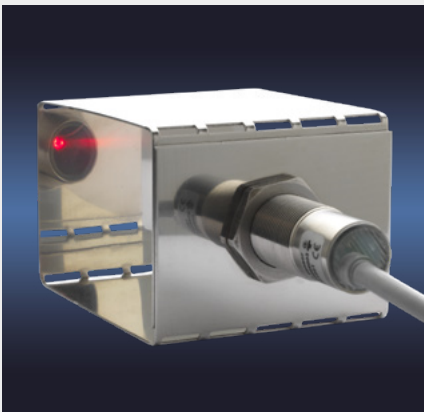

Monitoring system of duct networks (KGS)

SAFETY

Efficient and cost-effective prevention tool for hygiene and fire safety due to the assessment of grease build-up in the ductwork.

ECONOMIC ADVANTAGE

Allows for cleaning of ducts only when really necessary and not in a programmed and often unnecessary way. Maximum safety at minimum cost.

Technical descriptions

USR-S USR-S-OD

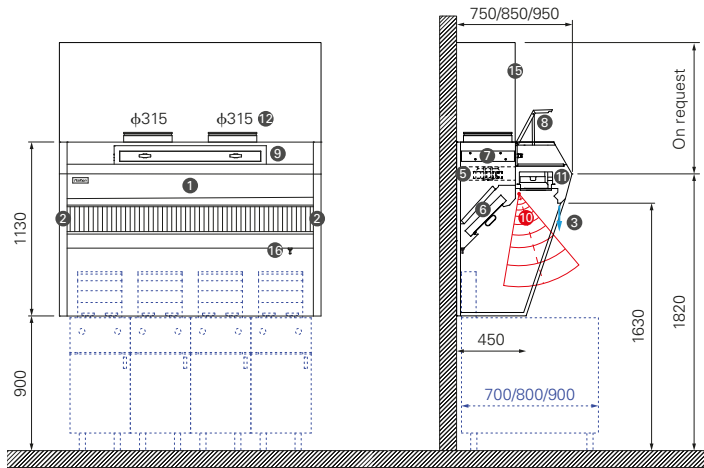

Caution
Electric cooking
appliances only

- 1 Outer casing in stainless steel AISI 304
- 2 Double skin sides
- 3 Front Capture Jet™ nozzles
- 4 Side Capture Jet™ nozzles
- 5 Integrated Capture Jet fan
- 6 KSA + MFA double stage filtration
- 7 UV lamps cassette
- 8 Main access hatch
- 9 UV access hatch
- 10 **Option** IRIS sensor(s) (UV on Demand version only)
Number and location depending on the cooking appliance(s)
- 11 Halton Skyline LED light fitting and UV controls
- 12 Exhaust air connection and adjustment dampers(s)
- 13 Services distribution module
- 14 Electric plugs
- 15 **Option** Cover board
- 16 Drain

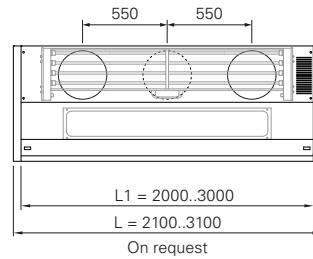
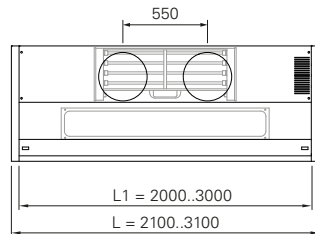
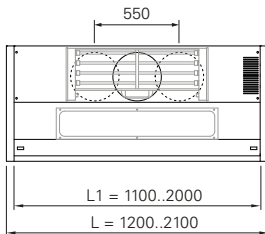

USR-F USR-F-OD

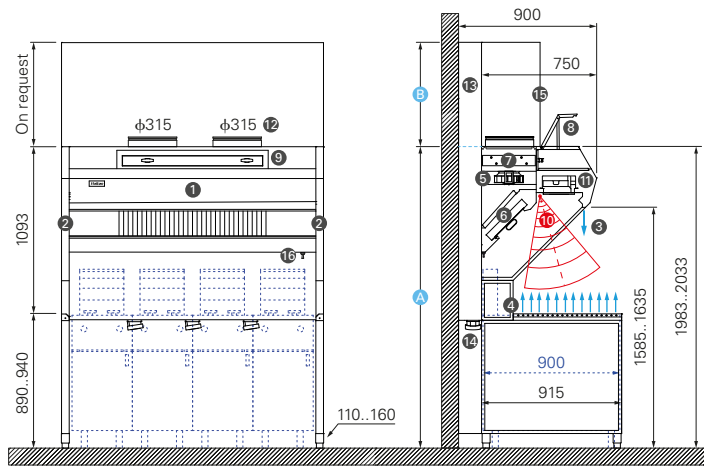

Caution
Electric cooking
appliances only

Caution
Above 2000 mm active length,
USR hood is delivered in two
parts (A and B).

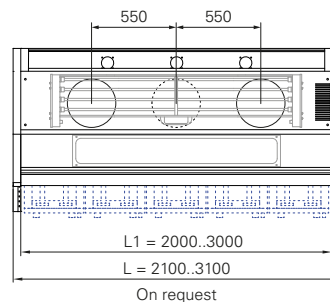
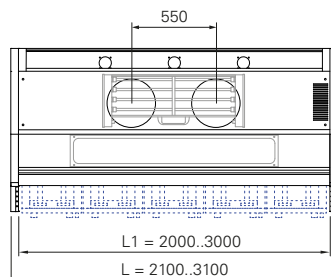
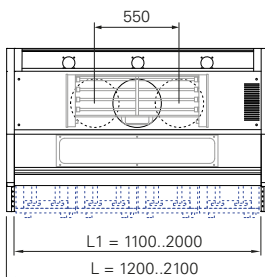

Specifications

USR-S / USR-F Hood

The hood shall be Halton Brand, USR range. This low profile with underhang hood type is equipped with the Capture Jet™ and Capture Ray™ technologies. The models shall be according to the projected exhaust devices list, depending on the additional options/features required:

- USR- S is the backshelf/suspended model when the USR-F is freestanding. This last model is also equipped with side Capture Jets to enable a large opening on the sides for passing the fries baskets.
- When the UV lamps are activated "On Demand" as an option, the models are USR-S-OD (backshelf) or USR-F-OD (freestanding).

The hood shall be supplied completed and ready to be installed. The following specifications shall be fully observed.

Hood outer casing

- Constructed from 1.0 mm AISI 304 stainless steel in a brushed satin finish. All exposed welds are ground and polished to the metal's original finish.
- Hood sides shall be of double-wall construction to reduce the condensation risk on the internal face.

Capture Jet™ technology

- The hood shall be equipped with the Capture Jet™ technology. Based on the use of two sets of nozzles on the lower part of the hood front. The Capture Jets improve the hood capture and containment efficiency. The exhaust airflow rates are thus reduced by up to 50% compared to traditional hoods, leading to huge energy savings.
- The air used for the Capture Jets shall not represent more than 5% of the calculated exhaust airflow and the air speed at nozzles outlet shall be a minimum of 8 m/s. Slot- or grille-type discharge shall not be used.
- The hood shall be supplied with an integrated fan to provide the required airflow and static pressure to the Capture Jet™ nozzles. Therefore, an additional supply air system is not required.

Exhaust and supply airflow rates

- The exhaust airflow rates shall be determined with a EN(1) 16282-1 based calculation method taking into account both the convective loads released by the cooking appliances and the hood capture efficiency according to ASTM 1704-12 standard. Both the exhaust airflow rates and capture efficiency shall be justified by a calculation note.
- Any modification of the hood installation height together with the input power, type and dimensions of the cooking appliances shall be brought to the attention of the hood manufacturer as they all significantly impact the exhaust airflow rates.

- The makeup air design, especially the balance between exhaust and supply, shall be entrusted to the hood manufacturer as it also impacts the exhaust airflow rates and capture efficiency. It is also key to preventing cross-contamination between the kitchen areas.

Exhaust plenum, filters and UV-C lamps

- The exhaust plenum shall be constructed from 1.0 mm AISI 304 stainless steel in a brushed satin finish. The lower part of the sides shall be welded for a durable tightness against condensates. All exposed welds are ground and polished to the metal's original finish. Its bottom edge shall be aerodynamically designed (no flat surface) thus helping the smoke and steam to freely rise toward the exhaust plenum, preventing steam spillage or stagnation leading to harmful dripping of condensation.
- It shall be equipped with a double stage filtration. The first shall be composed of KSA multi-cyclone grease filters, constructed from stainless steel. Their efficiency shall be at least 95% on 10 microns particles or larger, as tested by an independent laboratory. The filters shall also be NSF and UL classified. Baffle or slot type filters shall not be used. The second filtration stage shall be based on MFA mesh filters. This combination is a prerequisite for an efficient action of the UV-C lamps.
- The UV-C lamps shall be fitted in a cassette installed right after the double stage mechanical. Number and length of the UV-C lamps upon manufacturer recommendation. Lamps lifetime shall be at least 13000 hours. Ballasts shall not be integrated in the cassette to prevent a possible overheating and also to make it lightweight and easy to handle. The rack shall be mounted on runners and be equipped with quick electrical connectors to easily remove it without tool.
- The UV-C cassette shall be easily accessible for cleaning and maintenance, without tool and without having to remove the filters, by the mean of an access door equipped with lock handles having an easy grip.
- The exhaust connections shall be supplied with sliding balancing dampers. The exhaust plenum shall be equipped with T.A.B.™ pressure tap for quick airflow measurement.

Access safety to the UV-C lamps and lamps control

- The exhaust plenum shall be equipped with maintenance-free magnetic proximity switches in order to individually check the presence of each filter as well as the correct closing of the UV rack's access door. Pressure switches shall not be used for this check. Any access attempt to the UV lamps, whatever the circumstances, shall automatically lead to their automatic shut-off and to trigger an alarm.

- The control system shall include a pressure sensor to automatically switch off the lamps in case of fan shut down or unusual low pressure. A complementary interlock between the exhaust fan and the UV control system shall be set up, preventing in all cases the UV lamps to be on when the fan is off.
- Each hood section is equipped with a UV module composed of the controllers and ballasts. It is installed above the light fitting which shall be removable to enable a wide access for the system maintenance.

[Option] UV on Demand

- To extend the UV-C lamps usage period before replacement, the system shall be equipped with the UV on Demand function.
- To that purpose, each hood section shall be equipped with one or several IRIS Infrared Radiation Index Sensor(s). They are used to scan the cooking appliances' surface and monitor, real time, the variations in cooking activity. Connected to the hood controllers they automatically switch on the UV-C lamps during cooking processes only.

User interface (Halton's Touch Screen)

- A tactile LCD screen shall be used as user interface, fitted in a specific cabinet or built-in a wall.
- In user mode, it shall allow a fast and simple use of the systems, even by non-professional personnel. In administrator mode, it shall provide detailed information about the systems and technologies statuses, as well as fast access to some of the system settings during the commissioning phase and maintenance operations.
- The tactile screen shall display at least the following information or alarms:
 - System / Communication alarm and – if applicable- emergency stop or fire alarm;
 - UV / Activation of the lamps, number of operating hours, as well as low pressure, missing filter, access door opened, ballast fault, UV lamp fault or UV lamps replacement alarms.
- **[Option]** The tactile screen shall also manage all the other technologies delivered by the manufacturer as part of the kitchen ventilation system and therefore display additional information or alarms. Check the additional requirements specific to these technologies.
- The tactile screen shall be able to interlock with a computer and with the Building Management System (BMS).
- **[Option]** The tactile screen shall be connected to the building network to enable distant connection features.
- **[Option]** A dedicated web portal shall be provided and configured to monitor real-time the systems, save all data on a server and provide analytics. The additional specific requirements of this portal shall also be all observed.

[Option] M.A.R.V.E.L. Demand Controlled Ventilation

- The hood shall be equipped with M.A.R.V.E.L. Demand Controlled Ventilation system to automatically adjust, in real time, the exhaust airflow rates and this, hood section per hood section, in an independent manner and depending on the real cooking activity.
- To that purpose, each hood section shall be equipped with one or several IRIS Infrared Radiation Index Sensor(s). They are used to scan the cooking appliances' surface and monitor real-time variations in cooking activity.
- The reliability and sharpness of the airflow adjustment are reinforced by temperature sensors installed in each hood exhaust plenum. An additional room temperature sensor installed in the kitchen provides the required reference to the plenum temperature sensors.
- Each hood section is also equipped with an ABD damper used for real-time exhaust airflow adjustment.
- All hood section specific components are connected to a hood controller. This controller shall have the ability to make the hood section behave in a totally independent manner while communicating with all the other sections. These communication capabilities are a must for an efficient and required adjustment of the fan(s) speed.
- M.A.R.V.E.L. system shall be controlled by a tactile LCD screen. It shall allow a fast and simple use of the systems, even by non-professional personnel.
- **[Option]** The LCD screen shall also manage all the other technologies delivered by the manufacturer as part of the kitchen ventilation system. Check the additional requirements specific to these technologies.
- The additional requirements specific to M.A.R.V.E.L., especially concerning the balance between exhaust and supply together with the fan's speed control, will also be observed.

Halton Skyline light fitting

- Each hood shall be equipped with Halton Skyline Culinary Light. Constructed from stainless steel, the light fitting comprises flush-mounted broad beam spots with a diffusion angle of at least 80°. Each spot is composed of a patented mixing chamber and a specific reflector. Both shall provide a good balance between direct and diffuse light components without dazzling the staff. Especially, the shielding angle shall exceed DIN 12464-1 requirement and be at least 30°.
- The illuminance on the working surfaces shall be 750 lx with a CRI Colour Rendering Index of at least 83.
- The LEDs lifetime shall be 50,000 hours. The power supplies shall have at least the same lifetime and be DALI compatible. They shall enable switching on/off or dim the light (0-100%) with one or several switches.
- **[Option]** The power supplies shall also have a Constant Light Output feature, adjusting the output to keep the 750-lx illuminance required over LEDs lifetime.

- **[Option]** A specific DALI user interface with a simple scenario and zoning functions shall be used to control the light fittings installed in the hoods and/or ventilated ceilings and – if applicable – in the rest of the kitchen. Check the additional lighting requirements described in the present document.
- **[Option]** A specific DALI user interfaces with an advanced scenario and zoning functions, equipped with an LCD screen, shall be used to control the light fittings installed both in the hoods and/or ventilated ceilings and in the rest of the kitchens and related areas. Check the additional lighting requirements described in the present document.

[Option] Fire Suppression System

- The fire extinguishing system shall be from Ansul® R-102™ type and be pre-installed from the factory for better integration, at least for the plenum and exhaust connection(s) protection. The detection chain and fusible link(s) shall be fully integrated inside the exhaust plenum to not be visible at all.
- The cooking appliances nozzles shall, as much as possible, drop from the hood roof, without horizontal pipes visible inside the containment volume of the hood.
- The site complementary installation shall be carried out by the hood manufacturer or a certified partner. In all cases, it shall be an authorised representative of Ansul and the installation shall comply with UL 300 requirements and local codes.

(1) The European Standards published by CEN are developed by experts, established by consensus and adopted by the Members of CEN. It is important to note that the use of standards is voluntary, and so there is no legal obligation to apply them (source: CEN).

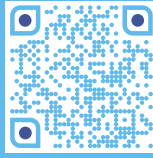

www.halton.com/foodservice

Halton Manufacturing Facilities

France

Halton Foodservice
Zone Technoparc Futura
CS 80102
62402 Béthune Cedex
Tel. +33 (0)1 80 51 64 00
Fax +33 (0)3 21 64 55 10
foodservice@halton.fr
www.halton.fr

Germany

Halton Foodservice
Tiroler Str. 60
83242 Reit im Winkl
Tel. +49 8640 8080
Fax +49 8640 80888
info.de@halton.com
www.halton.de

United Kingdom

Halton Foodservice
11 Laker Road
Airport Industrial Estate
Rochester, Kent ME1 3QX
Tel. +44 1634 666 111
Fax +44 1634 666 333
foodservice.uk@halton.com
www.halton.com

USA

Halton
101 Industrial Drive
Scottsville, KY 42164
Tel. +1 270 2375600
Fax +1 270 2375700
sales.us@halton.com
www.halton.com

Canada

Halton Indoor Climate Systems
1021 Brevik Place
Mississauga, Ontario
L4W 3R7
Tel. + 905 624 0301
Fax + 905 624 5547
sales.ca@halton.com
www.halton.com

Brazil

Halton Refrin
Rua Antonio de Napoli
539 Parada de Taipas
CEP 02987-030
São Paulo - SP
Tel. +55 11 3942 7090
vendas@haltonrefrin.com.br
www.haltonrefrin.com.br

Asia Pacific

Halton Group Asia Sdn Bhd
PT 26064
Persiaran Teknologi Subang
Subang Hi-Tech Industrial Park
47500 Subang Jaya, Selangor
Tel. +60 3 5622 8800
Fax +60 3 5622 8888
sales@halton.com.my
www.halton.com

China

Halton Ventilation
浩盾通风设备(上海)有限公司
Room 701, No.2277 Longyang Road,
Pudong New District
201204 Shanghai
Tel. +86 (0)21 6887 4388
Fax +86 (0)21 6887 4568
halton.cn@halton.com
www.halton.cn

Halton has a policy of continuous product development, therefore we reserve the right to modify design and specifications without notice. For more information, please contact your nearest Halton agency.

All rights reserved. No part of this publication may be reproduced, distributed, or transmitted in any form or by any means, including photocopying, recording, or other electronic or mechanical methods, without the prior written permission of the publisher, except in the case of brief quotations embodied in critical reviews and certain other non commercial uses permitted by copyright law.