

HMM SINGLE DUCT CABIN UNIT

For crew cabins, manual model



MATERIALS

PART	MATERIAL	NOTE
Casing	Hot galvanised steel	Available as an option: stainless steel EN 1.4404 (AISI316L)
Casing thickness	0.5 mm	As an option: 0.75/1.0 mm
Spigots	Hot galvanised steel and EPDM rubber	Available as an option: stainless steel EN 1.4404 (AISI316L)
Insulation	Mineral wool, s=20 mm, MED approved	As an option: s=25 mm
I/O unit	Aluminium/plastic/electronics	-
Reheat coil	Stainless steel EN 1.4301 (AISI304)	-
Cables	Halogen-free	-
Airflow measurement probes and tubes	Aluminium/polyurethane	-

HMM PRODUCT OPTIONS

- Manual cabin unit without reheater
- Manual cabin unit with reheater
- Network compatible with adapter. Available as an option with D03 control package

AVAILABLE REHEATERS

- Standard reheaters: 400W, 800W, 1200 W, 1500W with K01 control package
- Standard reheaters: 400W, 800W, 1200W, 1500W, 1800W with D03 control package

Practical power level may be software adjusted cabin by cabin. Cable and power supply design has to be done according to maximum available heating power.

APPLICATIONS

Halton HMM is a manually operated cabin unit for single duct applications. Airflow is controlled via an adjusting knob installed on the diffuser. The control mechanism has mechanical limits for minimum and maximum airflows. These limits can be easily set during commissioning. HMM is recommended to be used in conjunction with Halton's diffusers, as the mechanism has to be fixed to the diffuser's structure. The airflow is adjusted with diffuser knob. The HMM cabin unit can be supplied with reheater - controlled by a control panel.

FEATURES

- Pressure range from 50 Pa up to 1000 Pa
- Airflow range 0 m³/h...500 m³/h
- Airflow adjustment with diffuser knob
- Mechanical max./min. airflow limits for easy commissioning
- Airflow measurement probes
- MED approved for B-0 and B-15 installations

FEATURES WITH REHEAT MODELS

- 230 VAC ±10%, 50/60 Hz
- Triac controlled reheating coil(s), adjustable heating power (PWM) 0...100%
- Master/slave functionality: several cabin units can be controlled by one control panel
- Internal fuses included
- All parameters can be set onsite during commissioning by external device or preset at the factory
- All cable connections with fast connectors
- Easily tailored for different types of installations
- 90°C safety switch with state detection and manual reset
- HMM cabin unit is supplied with control panel and interconnection cable

GENERAL HMM DRAWINGS

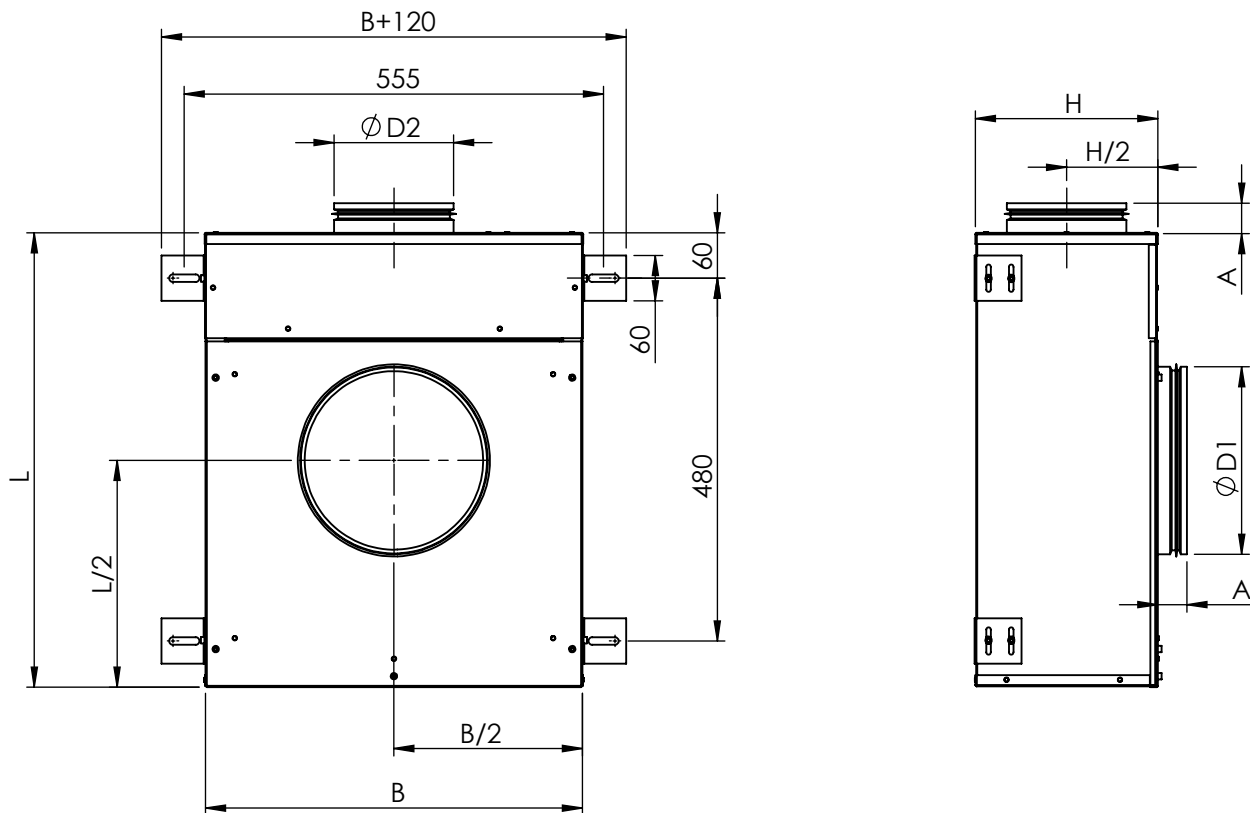

HMM DIMENSIONS, UNIT MATERIAL THICKNESS 0.5 MM

	L	B	H	A	ØD1 male/ female	ØD2 male
HMM-100	590	490	190	45	199/201	99
HMM-125	590	490	230	45	249/251	124
HMM-160	590	490	230	45	249/251	159

Note: male connection: outer dimension, female connection: inner dimensions. Special dimensions available for inlet 80 or 160 and outlet 160, 200 or 250. Sound and pressure drop data is limited for special dimensions.

HMM DIMENSIONS, UNIT MATERIAL THICKNESS 0.75/1.0 MM

	L	B	H	A	ØD1 male/ female	ØD2 male
HMM-100	600	500	200	40	199/201	99
HMM-125	600	500	240	40	249/251	124
HMM-160	600	500	240	40	249/251	159

Note: male connection: outer dimension, female connection: inner dimensions. Special dimensions available for inlet 80 or 160 and outlet 160, 200 or 250. Sound and pressure drop data is limited for special dimensions.

HMM WEIGHTS, KG

Casing thickness	HMM-100	HMM-125	HMM-160
0.5 mm	10.5	11.5	12
0.75/1.0 mm	15	16	16.5

Reheater + I/O unit +1kg

FUNCTION

Airflow is controlled via an adjustment knob between the preset limits.

MODELS WITH REHEATER

When passenger demands for warmer temperature by using control panel, the controller activates the electric reheater inside the cabin unit. When the required temperature in the cabin is achieved, the reference is held until the temperature demand changes. Mechanical maximum and minimum limits are set during commissioning.

REGULATION DIAGRAM WITH REHEATER

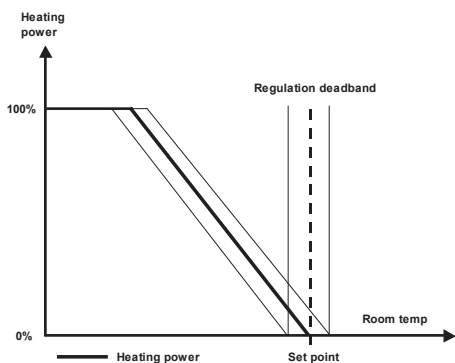

OPERATING RANGE FOR HMM WITHOUT REHEATER

HMM-100	HMM-125	HMM-160
0 m ³ /h - 350 m ³ /h	0 m ³ /h - 500 m ³ /h	0 m ³ /h - 500 m ³ /h

OPERATING RANGE FOR HMM WITH REHEATER

HMM-100	HMM-125	HMM-160
100 m ³ /h - 350 m ³ /h	100 m ³ /h - 500 m ³ /h	100 m ³ /h - 500 m ³ /h

ADJUSTMENT

The supply flow rate is determined by using the measurement probes and manometer. The diffuser front plate are removed and tubes are passed through the diffuser. Measure the differential pressure with a manometer. The flow rate is calculated using the shown formula. Adjust the minimum airflow rate by rotating the D-shape bar until the desired setting is achieved. Move the minimum airflow mechanical limiter against the stand and tighten socket cap screw. Adjust the maximum airflow rate by rotating the D-shape bar until desired setting is achieved. Move the maximum airflow mechanical limiter against the stand and tighten socket cap screw.

K-FACTORS TABLE

HMM	k
HMM-100	48.2
HMM-125	74.2

$$q_v = k * \sqrt{\Delta p_m}$$

q_v = airflow (m³/h)

k = k-factor

Δp_M = measured pressure (Pa)

CONTROL PANEL FEATURES

Halton Marine HMM cabin units are available with three different control panel models; with rotating knob, push buttons with LED bar graph (available as option: IP54) and push buttons with LCD-display (available as option: IP54).

COMMON FEATURES

- Cabin temperature measurement
- Connector for bluetooth / communication adapter to set cabin parameters
- Software for parameter setting and trouble shooting
- Different colour options and custom labeling available as an option
- Delivered with IC-Cable (interconnection cable)
 - For control panel - cabin unit connection
 - Prefabricated with plugs on both ends
 - Cable plug on panel side is designed to be pulled through standard installation pipe
 - Halogen free and flame-retardant
 - Standard length 7 meters. Other lengths available.

CONTROL PANEL WITH ROTATING KNOB

- Temperature adjustment by rotating knob

CONTROL PANEL WITH PUSH BUTTONS AND LED BAR GRAPH

- Temperature adjustment by push buttons
- Self diagnose function
- LED intensity control and auto dimming

CONTROL PANEL WITH PUSH BUTTONS AND LCD-DISPLAY

- Temperature adjustment by buttons
- Self diagnose function
- LCD intensity control and auto dimming
- Display for actual and set point temperatures available as an option
- Time display available as an option
- A customized background picture available as an option
- Several frame options available

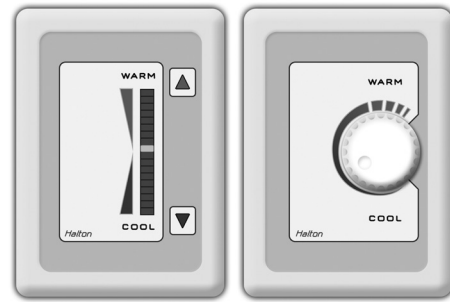

Control panel models; push button and rotating knob

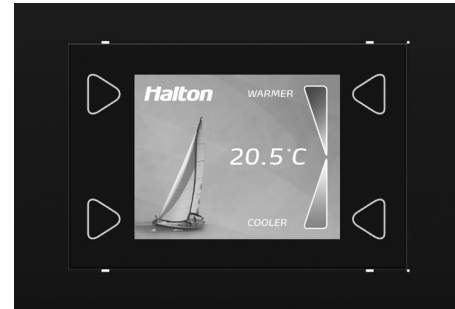

LCD control panel

CABIN VENTILATION CONFIGURATION TABLE

	UNIT	HMM	HMM	HME	HME	HMF	HMF	HMF	HFR/M	HFR/M	HFR/M	HMR	HMR	HML
	CONTROL PACKAGE	K01	D03	K01	D03	M00	M01	M02	M00	M01	M02	D21	H21	B00
TERMINAL UNIT WITH JUNCTION BOX	Damper	Manual	Manual	Manual	Manual	Electric	Electric	Electric	Electric	Electric	Electric	Electric	Electric	Electric
	Airflow measurement and control (VAV, CAV)	No	No	No	No	Yes	No	Yes	Yes	No	Yes	Yes	Yes	Yes
	In-box temperature measurement	Yes	Yes	Yes	Yes	Yes	Yes	Yes	Yes	Yes	Yes	No	No	Yes
	Reheater safety switch, manual reset	Yes	Yes	Yes	Yes	Yes	Yes	Yes	Yes	Yes	Yes	No	No	Yes
	Safety switch state detection	No	Yes	No	Yes	Yes	Yes	Yes	Yes	Yes	Yes	No	No	Yes
	Spare inputs (balcony door etc.)	No	No	No	No	Yes	Yes	Yes	Yes	Yes	Yes	Yes	Yes	Yes
	Parameter setting by service tool	No	Yes	No	Yes	Yes	Yes	Yes	Yes	Yes	Yes	Yes	Yes	Yes
CONTROL PANEL	Cabin temperature measurement	Yes	Yes	Yes	Yes	Yes	Yes	Yes	Yes	Yes	Yes	Yes	Yes	Yes
	Controller with push buttons, 18 led bar	No	Yes	No	Yes	Yes	No	No	Yes	No	No	Yes	No	Yes
	Controller with knob	Yes	No	Yes	No	No	Yes	Yes	No	Yes	Yes	No	Yes	No
	LCD room thermostat	No	Optional	No	Optional	Optional	No	No	Optional	No	No	Optional	No	Optional
	LED intensity control and auto dimming	No	Yes	No	Yes	Yes	No	No	Yes	No	No	Yes	No	Yes
	Self diagnose functionality	No	Yes	No	Yes	Yes	No	No	Yes	No	No	Yes	No	Yes
	Network compatible with adapter	No	Yes	No	Yes	Yes	Yes	Yes	Yes	Yes	Yes	Yes	No	Yes
CO2 sensor available as an option	No	Yes	No	Yes	Yes	No	No	Yes	No	No	Yes	No	Yes	
CABLES	Interconnection cable	IC4-X	IC6-X	IC4-X	IC6-X	IC6-X	IC6-X	IC6-X	IC6-X	IC6-X	IC6-X	IC6-X	IC6-X	IC6-X
	Master-slave cable	MS4-X	MS2-X	MS4-X	MS2-X	MS2-X (MS5-X)	MS3-X	MS3-X	MS2-X (MS5-X)	MS3-X	MS3-X	MS2-X	MS3-X	MS2-X

Please note: HMM and HME units are also available without a control package.

MANUALLY CONTROLLED AIRLOWS

- Single duct units; HMM, HME

PRESSURE DEPENDENT UNITS

- Single duct units; HMF, HFR/M

PRESSURE INDEPENDENT UNITS

- Single duct units; HMF, HFR/M, HML
- Dual duct units; HMR

ACCESSORIES FOR HMM CABIN UNITS**MS-CABLE (MASTER-SLAVE CABLE)**

- For master cabin unit - slave cabin unit/units connection
- Prefabricated with plugs on both ends
- Halogen free and flame-retardant
- Standard length is 7 meters. Other lengths available as an option.

COMMUNICATION ADAPTER

- Bluetooth communication to external device (only with D03 control package)
- For wireless connection to set cabin unit parameters and trouble shooting (only with D03 control package)

NETWORK ADAPTERS

- Network adapter (also available as WiFi) expands a stand-alone unit to network compatible unit (LON or Ethernet network)
- Enables supervision and advanced energy efficiency functions
- For more information, contact Halton Marine Sales

PERFORMANCE DATA

SOUND LEVELS, CABIN SOUND ABSORPTION 4 DB(A)

HMM-100-160

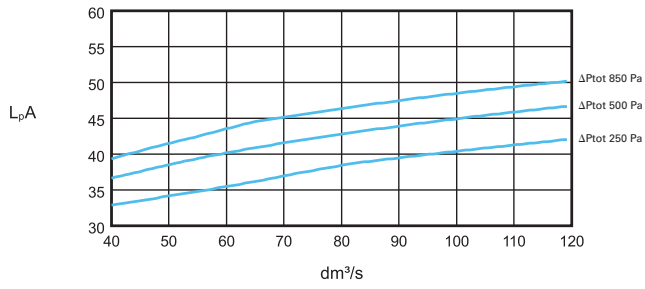

HMM-100-200

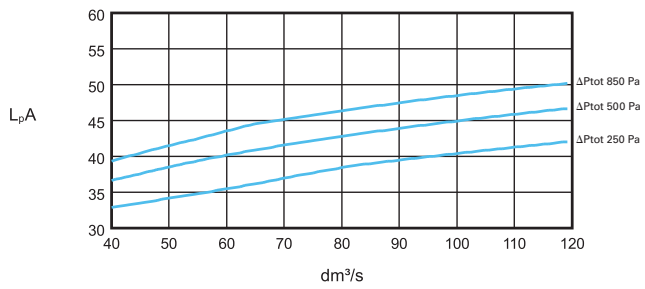

HMM-100-250

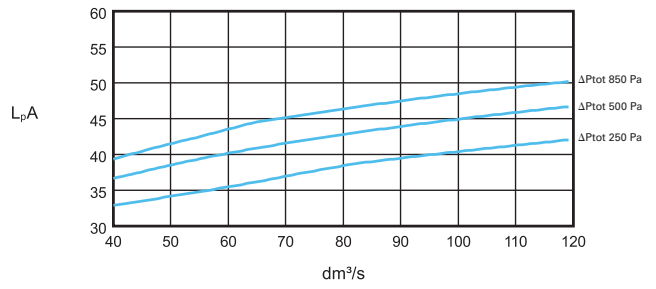

HMM-125-160

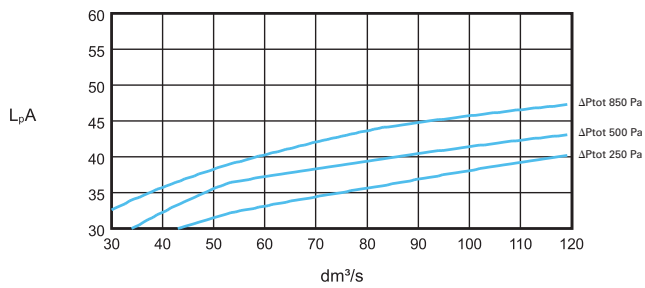

HMM-125-200

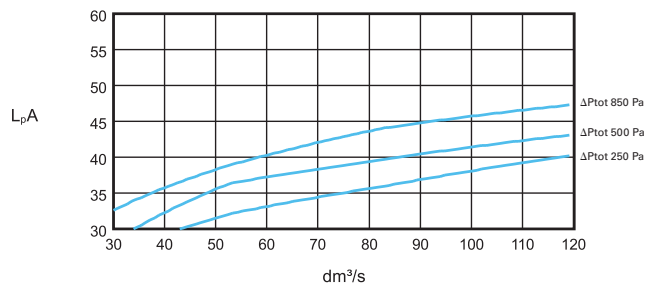

HMM-125-250

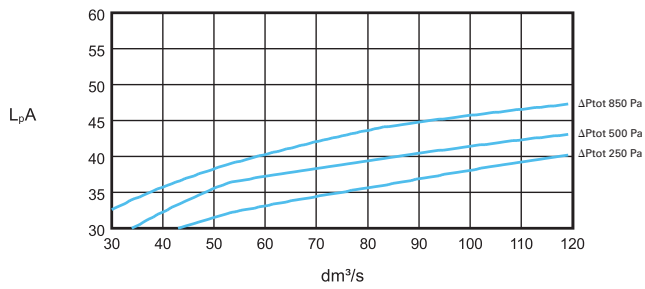

PRESSURE DROP

HMM-100-160

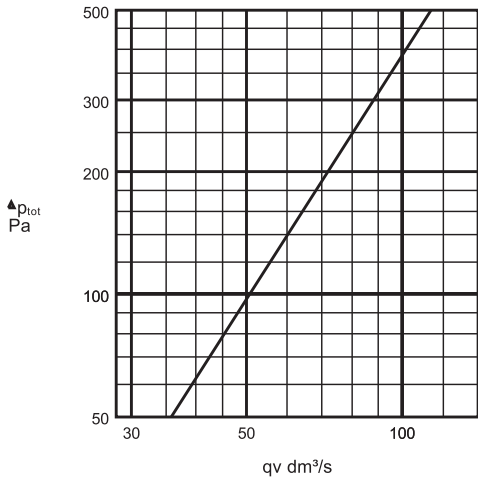

HMM-100-200

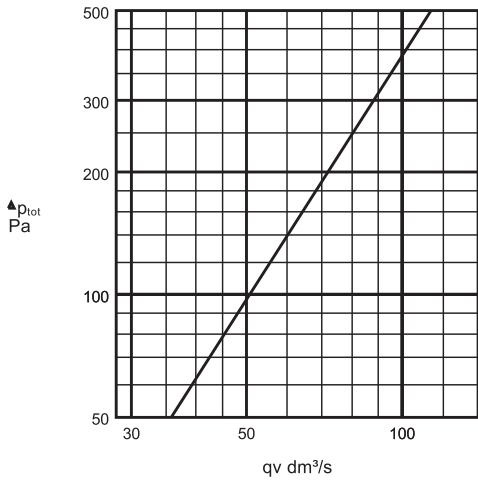

HMM-100-250

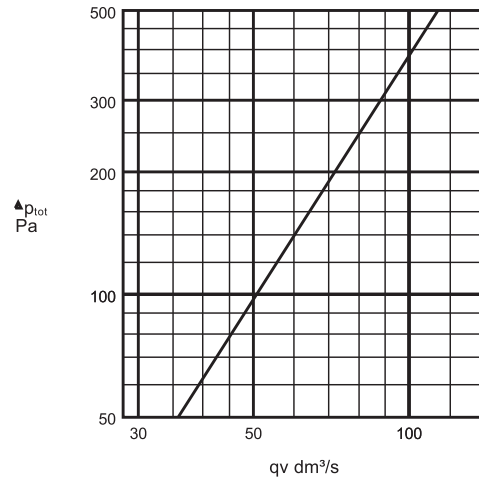

M07Y2024/Halton reserves the right to alter products without notice.

HMM-125-160

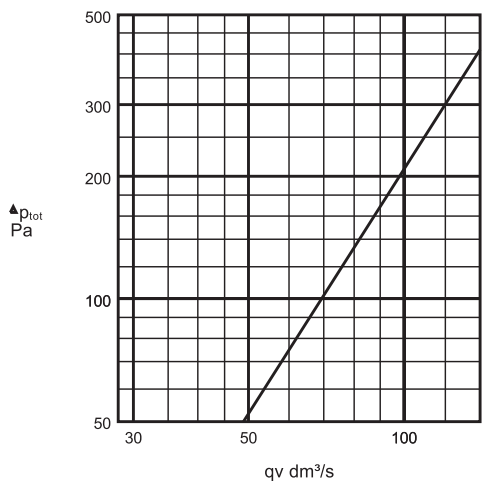

HMM-125-200

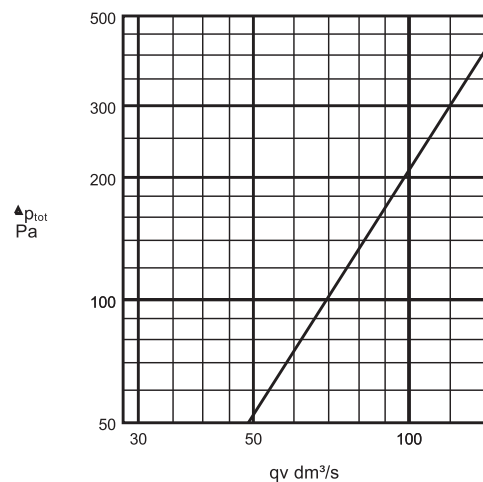

HMM-125-250

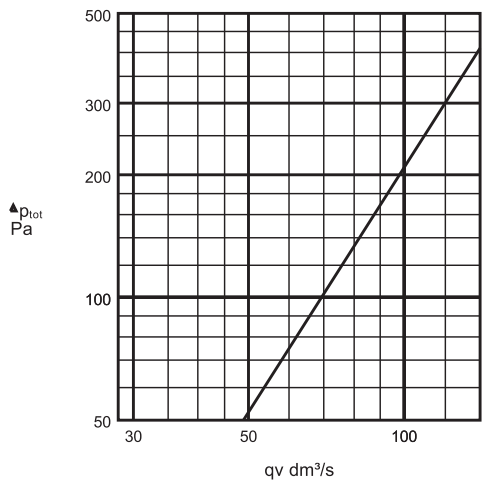

SOUND ATTENUATION (DB)

	f(Hz)	63	125	250	500	1000	2000	4000	8000
HMF-100	ΩL(dB)	6.4	11.3	15.9	25.8	34.8	37.9	35.3	34.7
HMM-125	ΩL(dB)	4.9	9.6	16.2	24.9	33.4	36.8	35.4	35.6

ΩL: Sound attenuation not including end reflection

M07Y2024/Halton reserves the right to alter products without notice.