

# DSH HIGH-EFFICIENCY DROPLET SEPARATOR

For demanding applications



## MATERIALS

PART	MATERIAL	FINISHING
Droplet separator	Aluminium EN AW 6060	Painted RAL9010, C3 acc. standard* ISO 12944-2 as standard
Droplet separator	Stainless steel EN 1.4404 (AISI316L)	Painted as an option
Mask louvre	Aluminium EN AW 5754 / AW 6060	Painted RAL9010, C3 acc. standard* ISO 12944-2 as standard
Mask louvre	Stainless steel EN 1.4404 (AISI316L)	Painted as an option
Frame	Aluminium EN AW 5754	Painted RAL9010, C3 acc. standard* ISO 12944-2 as standard
Frame	Stainless steel EN 1.4404 (AISI316L)	Painted as an option
Net	Stainless steel EN 1.4404 (AISI316L)	-
Filter	ISO Coarse 70% panel filter or ePM2,5 65% bag filter, other types available on request	-

\*) C3 durability of 7-15 years. C5-M with the durability of 15-25 years durability, available as an option.

## PRODUCT OPTIONS

Halton DSH is commonly delivered as a single-stage, two-stage or three-stage model:

- The single-stage unit comprises DSH vane section only, vane pitch can be 28mm, 23mm or 18mm
- The two-stage units comprise DSH+panel filter or DSH+bag filter
- The three-stage units comprise DSH+panel filter+DSH or DSH+bag filter+DSH

Special configurations are available.

## APPLICATIONS

Halton's DSH high-efficiency droplet separators are designed for demanding applications such as marine, oil & gas, chemical, energy industries, where reliability, easy installation and special design play an important role. Droplet separators operate on the principle of inertial vane separation and are designed to restrict the penetration of moisture, salt spray, rainwater and airborne aerosol particles into HVAC systems, engine room intakes, machinery spaces, and diesel and gas turbine engine air intakes.

Three configurations are commonly used according to the level of droplet removal efficiency required, single-stage, two-stage, and three-stage, but special configurations are also available. Two and three-stage units will include a coalescing and particulate filter. Halton can assist in the design and selection of the droplet separator according to the application with special consideration to the pressure drop, velocity, wind speed and direction, turbulence, and drainage.

## FEATURES

- High droplet and moisture separation efficiency
  - Class A results (EN 13030:2001)
  - Minimum pressure drop
- Performance tested according to EN 13030:2001 test for louvres subjected to simulated rain, at the independent laboratory
- Independent droplet removal efficiency testing carried out for single-stage, two-stage and three-stage configurations
- Tailored sizes and designs, such as modular construction, according to customer's needs
- For wall and duct installations
- Two and three-stage units will include a coalescing and particulate filter. Normally these are an ISO Coarse 70% panel filter or ePM2,5 65% bag filter
- The option of a mask louvre (ML) is available to architecturally disguise the vertical vane sections
- A possibility to connect with Halton fire or shut-off dampers resulting in saving of the space
- Easy installation and commissioning. No special maintenance required

**GENERAL DSH DRAWINGS**

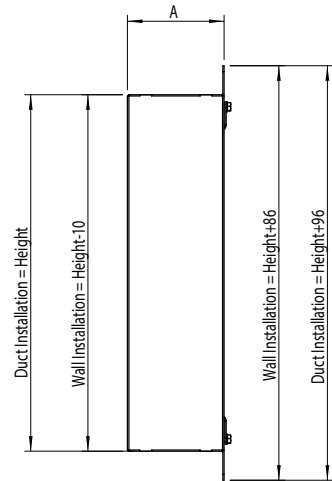
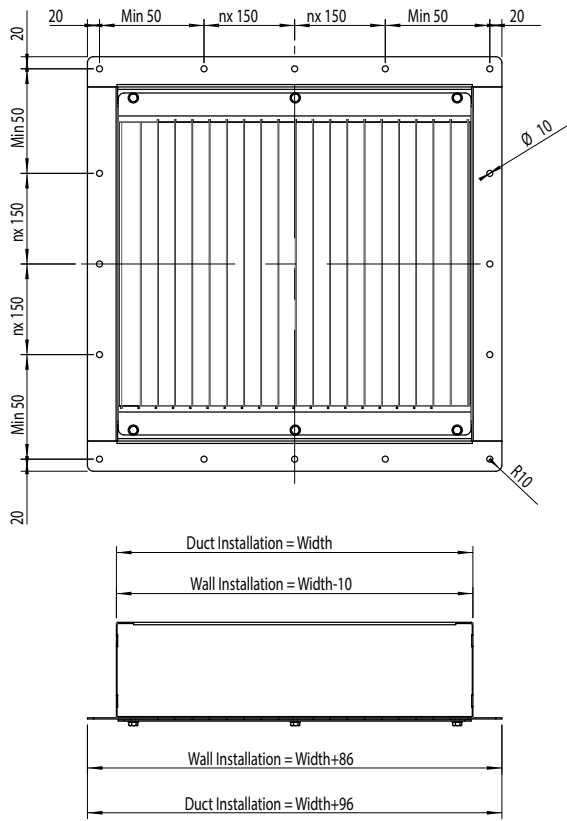

Please note that flanges in accordance with Norsok / ISO15138 are available as an option.

Special flange configurations available on request.

**DSH DIMENSIONS**

TYPE	A	
	Wall installation	Duct installation
DSH	160	170
DSH+ML	210	-
DSH+panel filter	225	235
DSH+panel filter+ML	275	-
DSH+bag filter	595	605
DSH+ML+bag filter	645	-

- DSH = droplet separator
- DSH+ML = droplet separator + mask louvre
- DSH+panel filter = droplet separator + ISO Coarse 70% panel filter
- DSH+panel filter+ML = droplet separator + ISO Coarse 70% panel filter with depth 360mm + mask louvre
- DSH+bag filter = droplet separator + ePM2,5 65% bag filter with depth of 300 mm
- DSH+ML+bag filter = droplet separator + mask louvre + ePM2,5 65% bag filter with depth of 360 mm
- Net available as an option.

**MATERIAL THICKNESS**

Standard frame thickness of 2 mm. 3 mm available as an option.

## DSH FACE AREA DIMENSIONS

DSH SINGLE UNIT

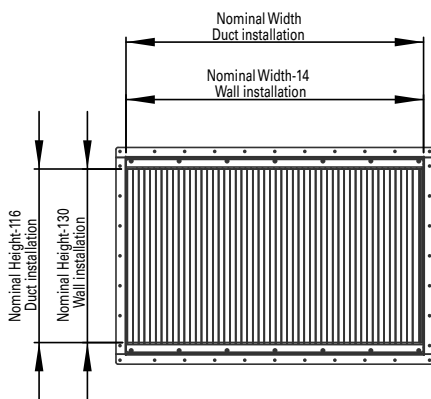

DSH MODULE UNIT (WIDTH)

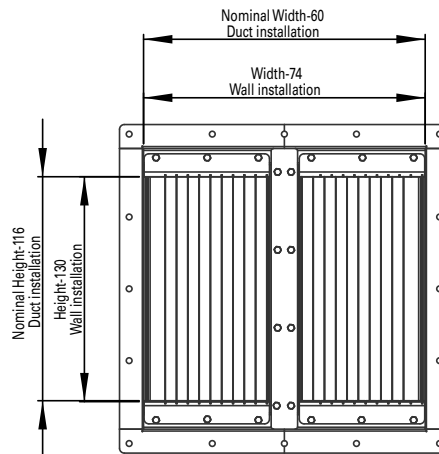

DSH MODULE UNIT (HEIGHT)

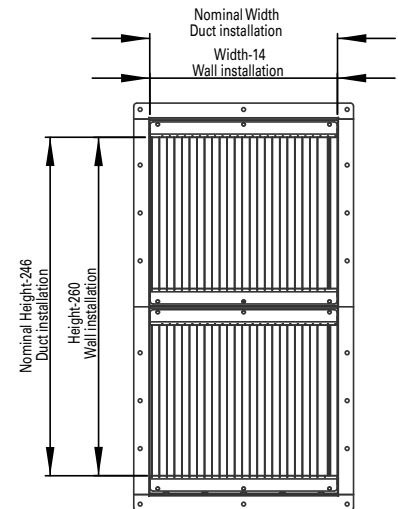

For example wall installation DSH  
Size: width 600 mm, height 600 mm  
= face area: width 586 mm, height 470 mm

## GENERAL CONSTRUCTION

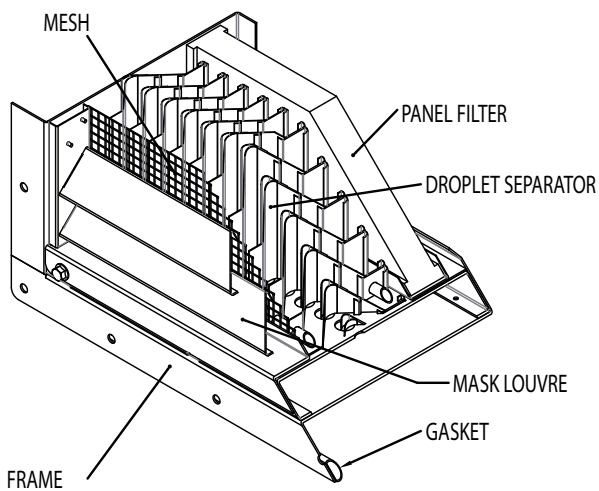

- The single-stage unit comprises DSH vane section only, vane pitch can be 28mm, 23mm or 18mm
- Two-stage units comprise DSH+panel filter or DSH+bag filter
- Three-stage units comprise DSH+panel filter+DSH or DSH+bag filter+DSH
- Special configurations are available
- Mask Louvre (ML) and mesh (ME) are available as an option
- The mesh (ME) prevents objects from entering the air intake system
- The mask louvre (ML) is available to architecturally disguise the vertical vane sections
- Access to filter for removal and maintenance is LH (left hand) or RH (right hand) as standard

**DRAINAGE**

Single-stage units are supplied with front drain holes or with drainage pipes. Two and three-stage units are normally supplied with a EN 1.4404 manometric drain trap to prevent unfiltered air by-passing the droplet separator.

**DRAIN LOCATIONS**

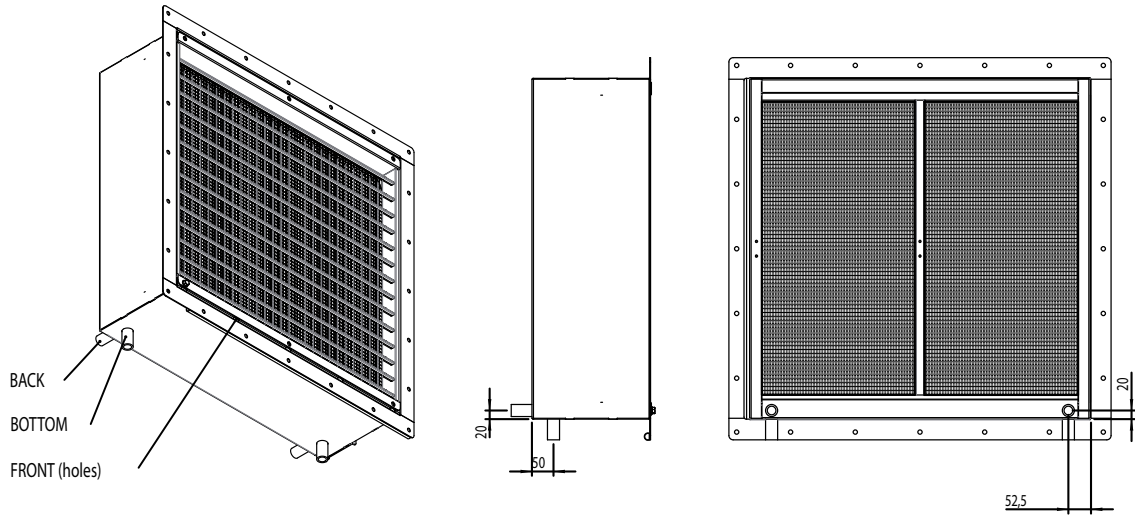

**DRAIN PIPE SIZES**

Weld-on nipple	Size	L mm	A mm	d1 mm	d2 mm
	1/2	50	20	15	22
Aluminium	3/4	50	20	20	28
	1	60	25	25	35
Stainless steel AISI 316	1/2	35	15	16	21
	3/4	40	15	22	27
	1	40	20	26.5	34

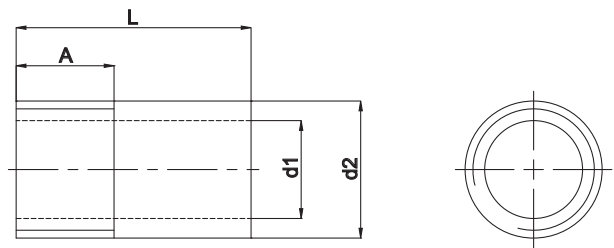

Standard size is 3/4". 1/2" and 1" are available as an option. Thread type BSPT (male).

**OPTIONAL FEATURES**

**SERVICE HATCH (SH)**

Enables easy access to the filter from the side of the unit. Hatch can be placed to the left side (HL) or the right side (HR) of the DSH. (ISO Coarse 70% panel filter in the picture).

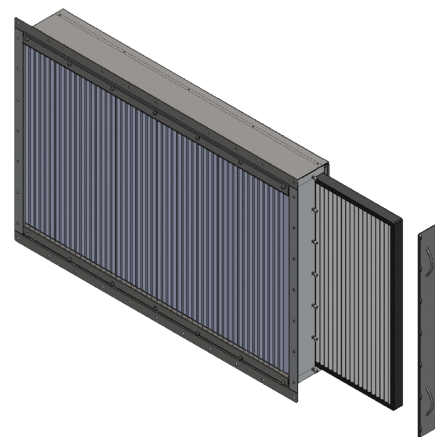

### ISO COARSE 70% PANEL FILTER

Panel filters are manufactured of progressive thermally smoothed synthetic polyester having high dust holding capacity and constancy for humidity. The filters are used in the general ventilation system for air purification.

### EPM10 70%, EPM2,5 65% AND EPM1 50% BAG FILTERS

The materials of the synthetic fine filters are high-quality and durable, progressive mounted synthetic fibres. The filters can be used in example for air purification of the intake air.

### ATEX APPROVED FILTERS

Halton also offers ATEX approved filters for droplet separators.

### INSTALLATION IN CONJUNCTION WITH A DAMPER

Halton droplet separator can be connected to a Halton damper with or without a connection piece. In both cases, the construction is modified to fit the damper. Connecting DSH with a fire damper must be mentioned when ordering products. Special flanges and drilling patterns are available for all models on request. The structural flexibility of dampers and high-quality combined with a wide range of accessories (ex-actuators) and special steels, enable Halton to offer tailored solutions for its customers.

Combining Halton droplet separator to damper offers customers a compact solution for air intake that also saves space. The products are recommended to be connected at Halton factory.

### WEATHERTIGHT HATCH

Weather-tight hatch is used e.g. to shut down the intake close to the waterline in the event of rough seas. See a separate brochure on weather-tight hatch called Halton WTH.

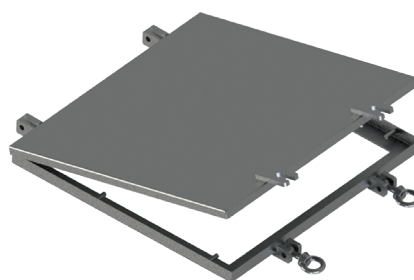
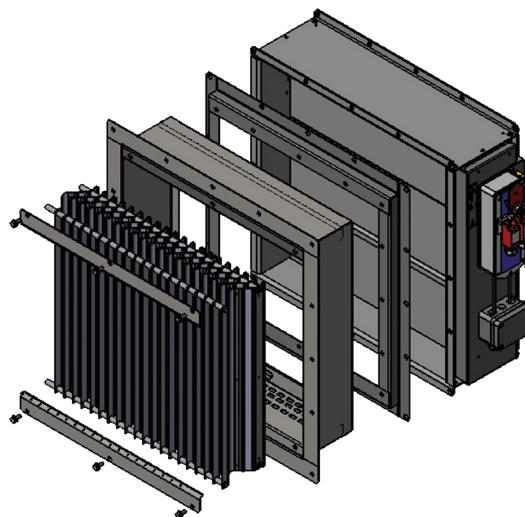
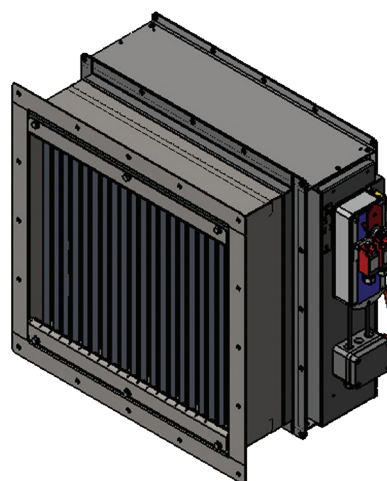
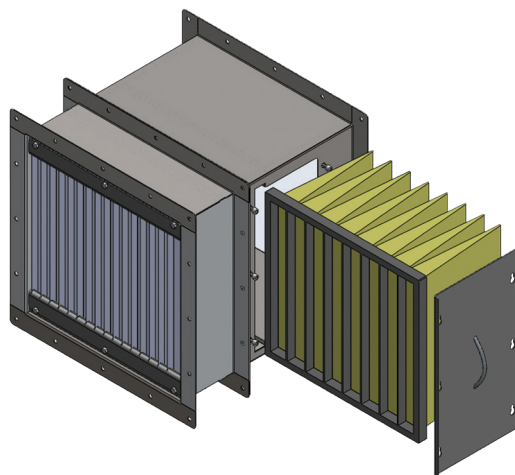

**PRESSURE DROP AND SOUND DATA LWA[DB(A)], PITCH SPACING 28. VELOCITY IS BASED ON FACE AREA**

DSH aluminium

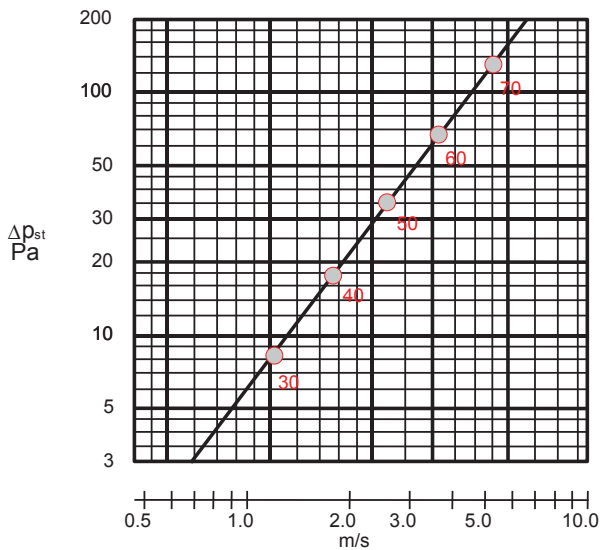

DSH stainless steel

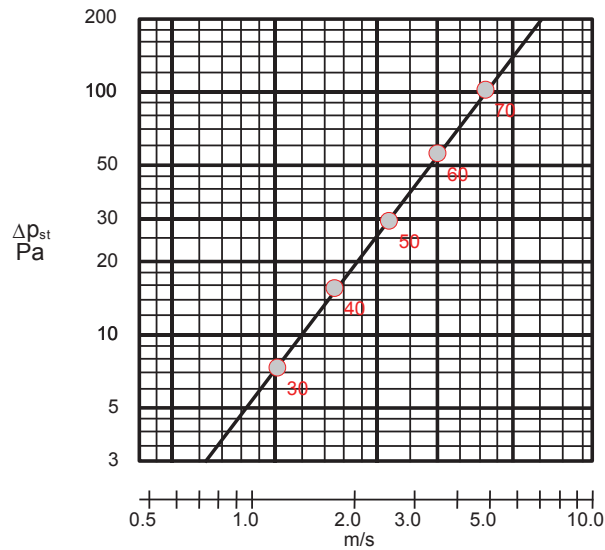

DSH aluminium with ISO Coarse 70% panel filter

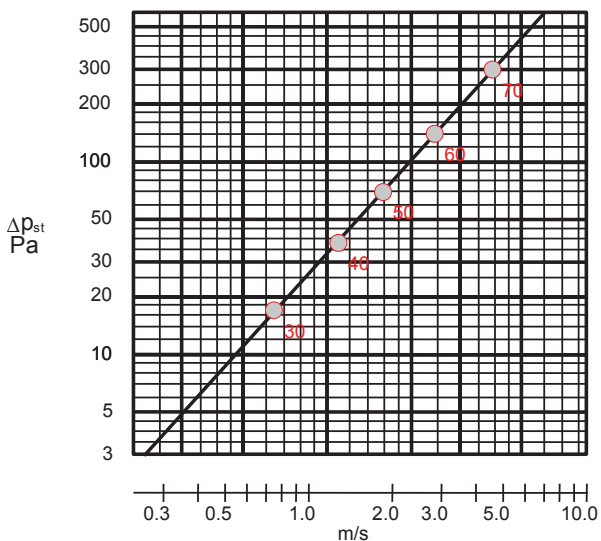

DSH stainless steel with ISO Coarse 70% panel filter

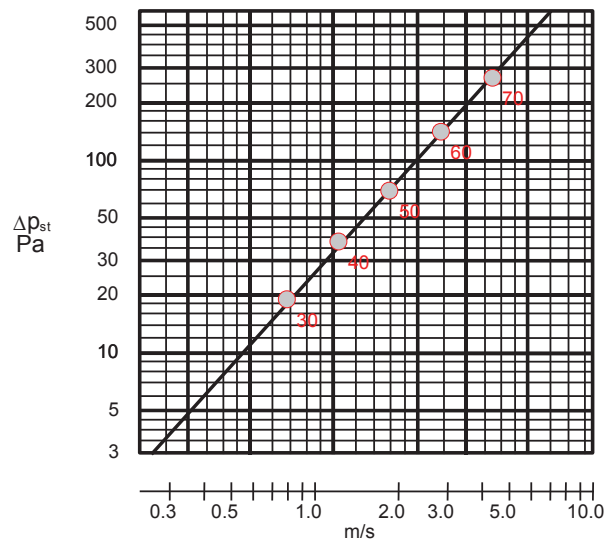

DSH aluminium with ePM2,5 65% bag filter

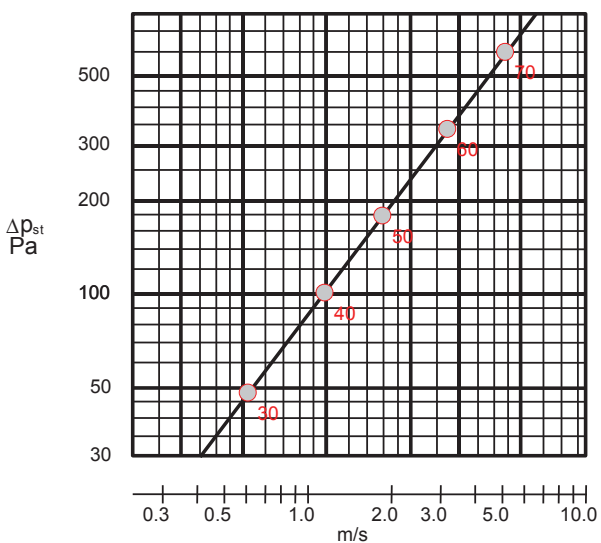

DSH stainless steel with ePM2,5 65% bag filter

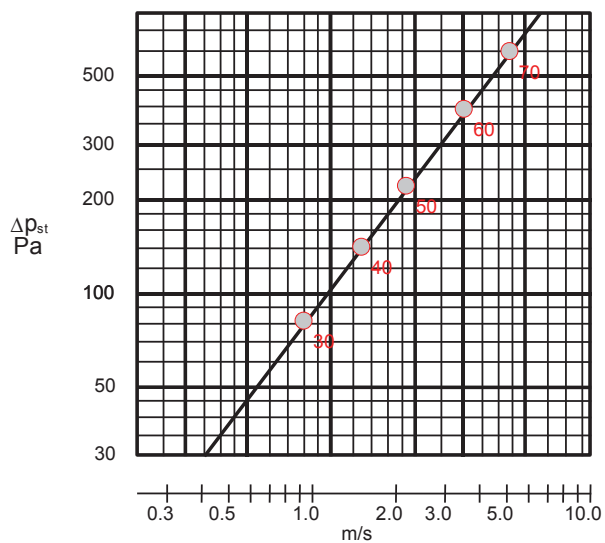

M07\2024\Halton reserves the right to alter products without notice.

**PRESSURE DROP AND SOUND DATA LWA[DB(A)], PITCH SPACING 28. VELOCITY IS BASED ON FACE AREA**

DSH aluminium with mask louvre

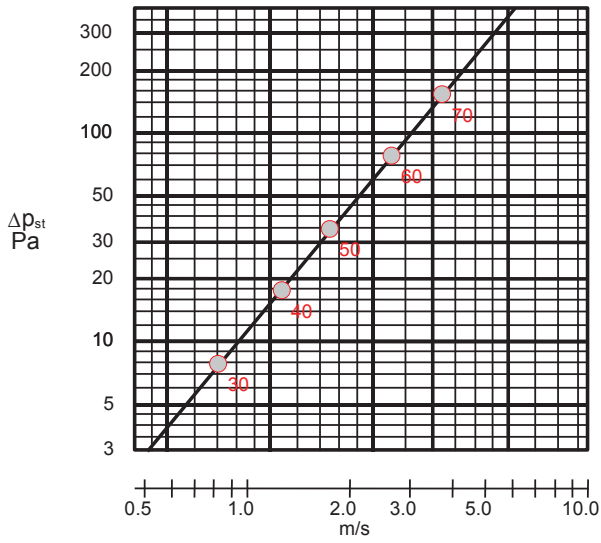

DSH stainless steel with mask louvre

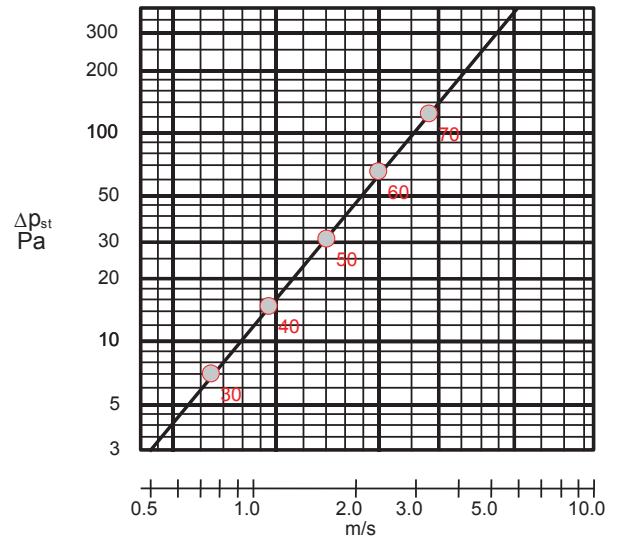

DSH aluminium with mask louvre and ISO Coarse 70% panel filter

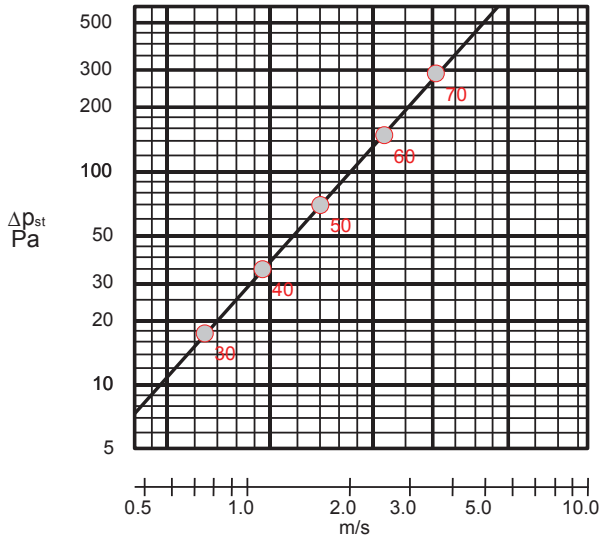

DSH stainless steel with mask louvre and ISO Coarse 70% panel filter

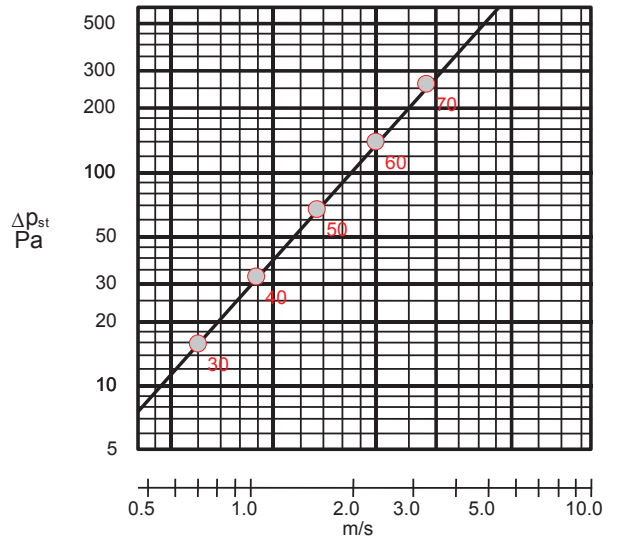

DSH aluminium with mask louvre and ePM2,5 65% bag filter

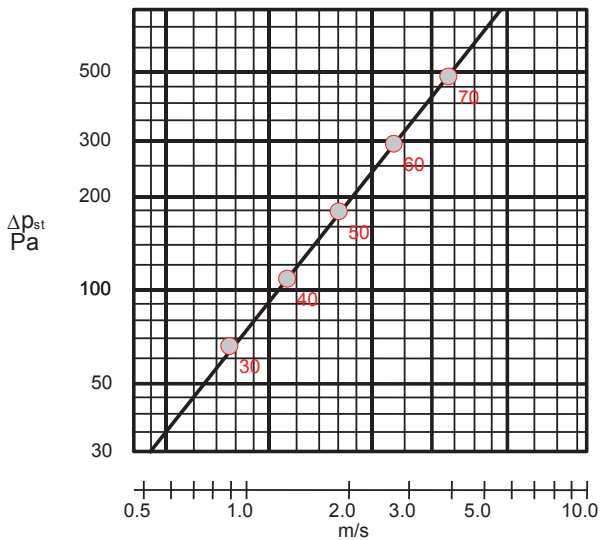

DSH stainless steel with mask louvre and ePM2,5 65% bag filter (measured size 1000 x 1000 mm)

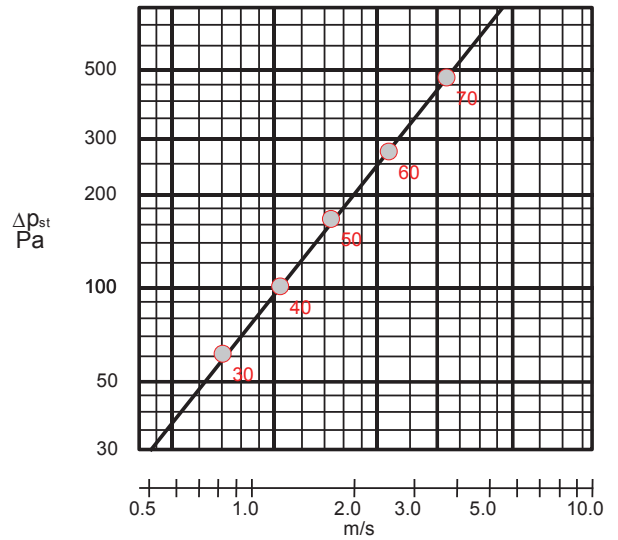

**PRESSURE DROP, PITCH SPACING 18 MM.**

**VELOCITY IS BASED ON FACE AREA**

DSH stainless steel

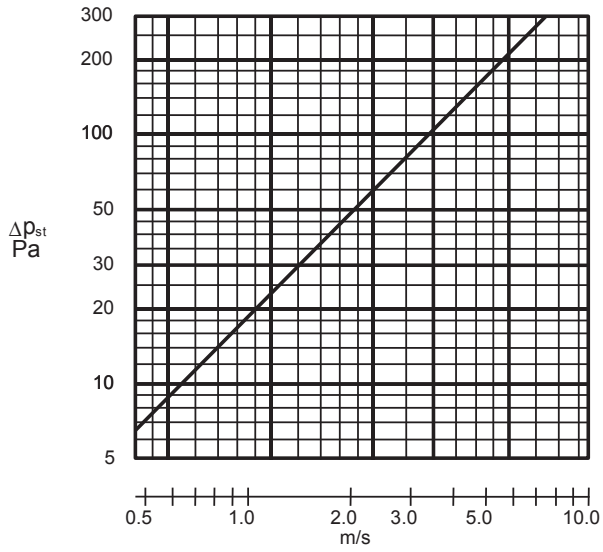

**PRESSURE DROP, PITCH SPACING 23 MM.**

**VELOCITY IS BASED ON FACE AREA**

DSH stainless steel

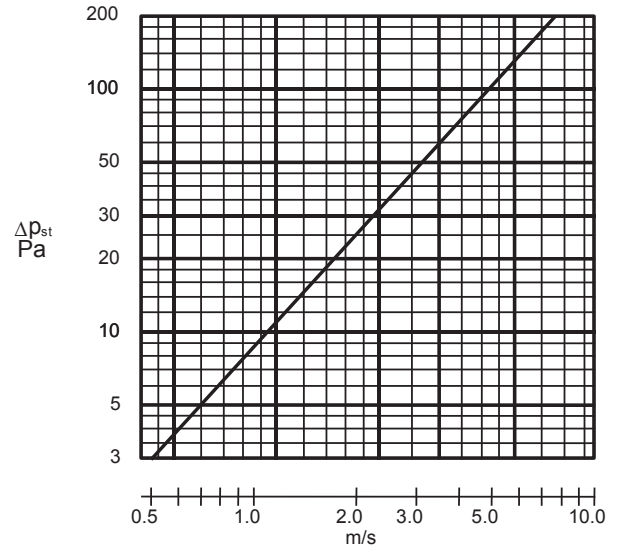

**DSH PRESSURE DROP, PITCH SPACING 18 MM, THREE STAGE DROPLET**

DSH stainless steel with ePM2,5 65% bag filter and DSH stainless steel

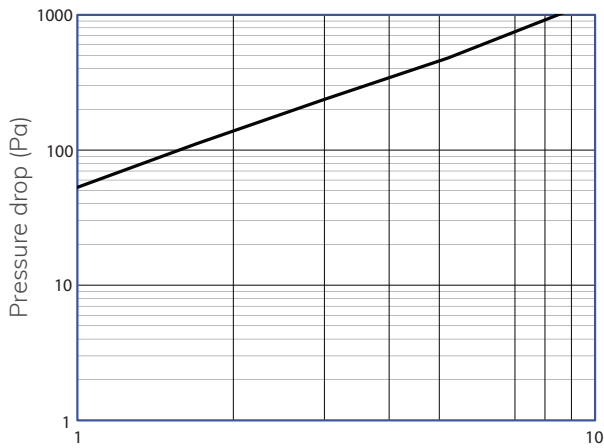

Air velocity at the face area of the droplet separator (m/s).

DSH stainless steel with ISO Coarse 70% panel filter and DSH stainless steel

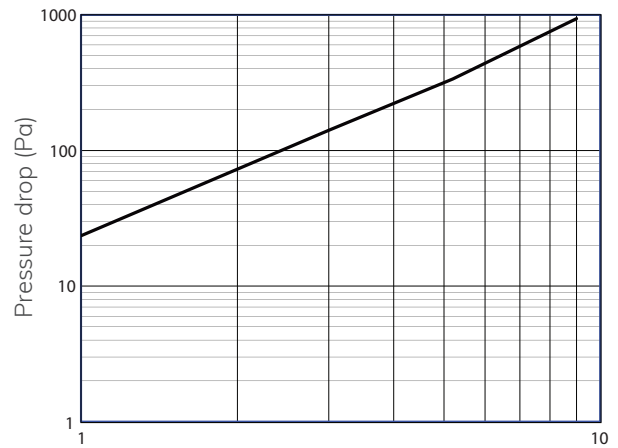

Air velocity at the face area of the droplet separator (m/s).

Please note: Pressure drop is dependent on total configuration. Please contact Halton for further information.



**DSH EFFICIENCY RESULTS**

Three-stage droplet separator with ISO Coarse 70% panel filter

Three-stage droplet separator with ePM2,5 65% bag filter

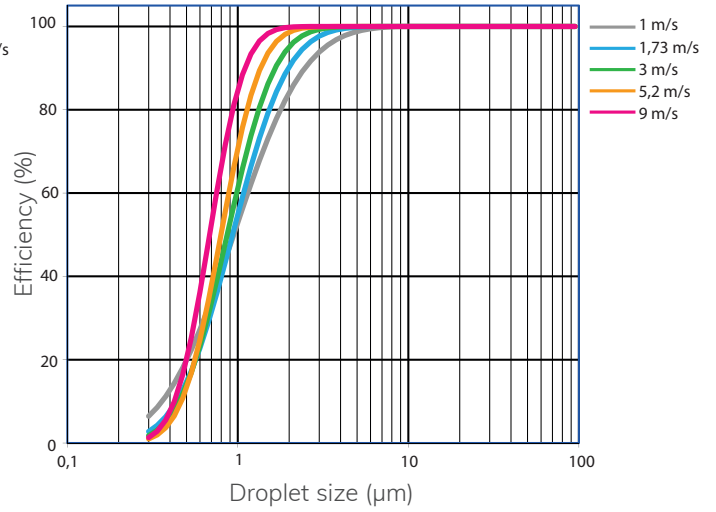
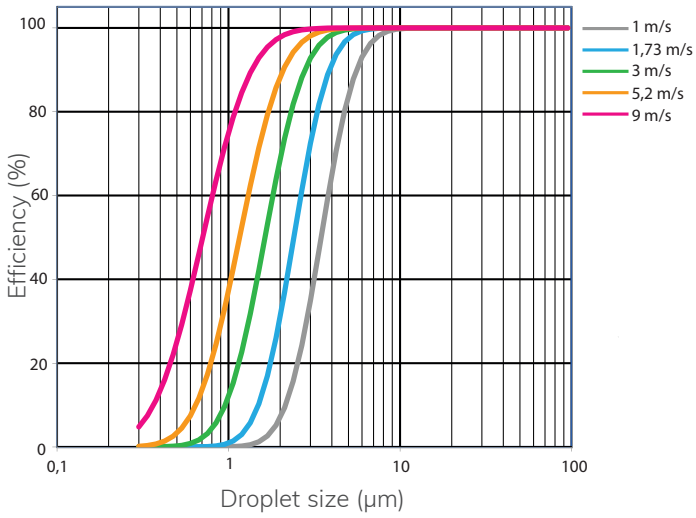

Single-stage DSH, pitch spacing 18 mm

Single-stage DSH, pitch spacing 23 mm

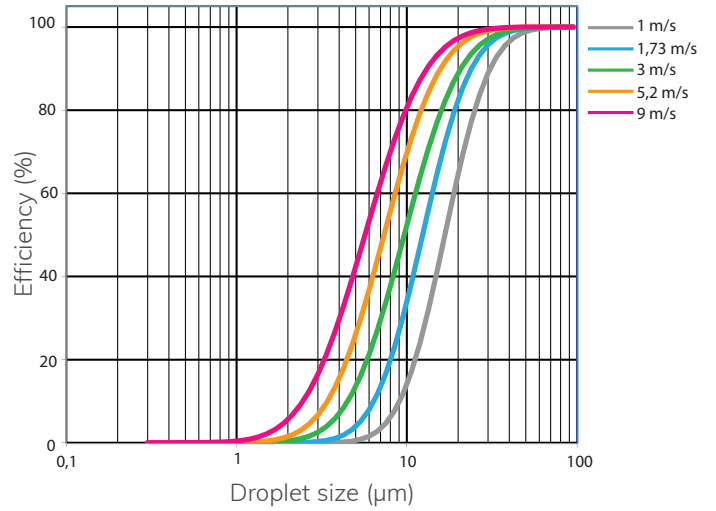
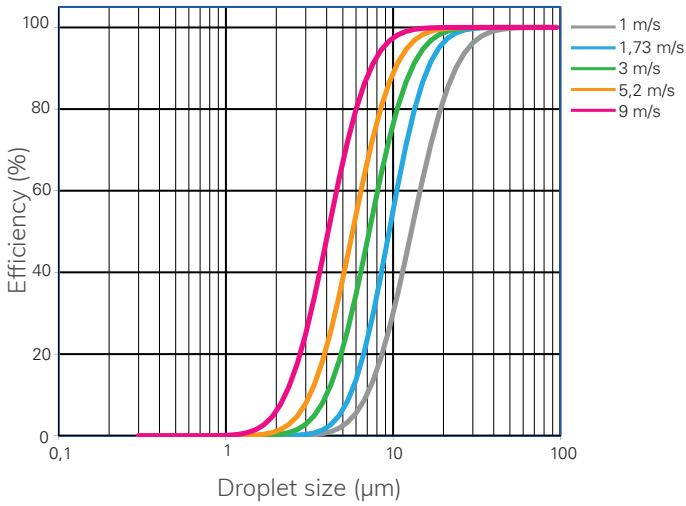

Single-stage DSH, pitch spacing 28 mm

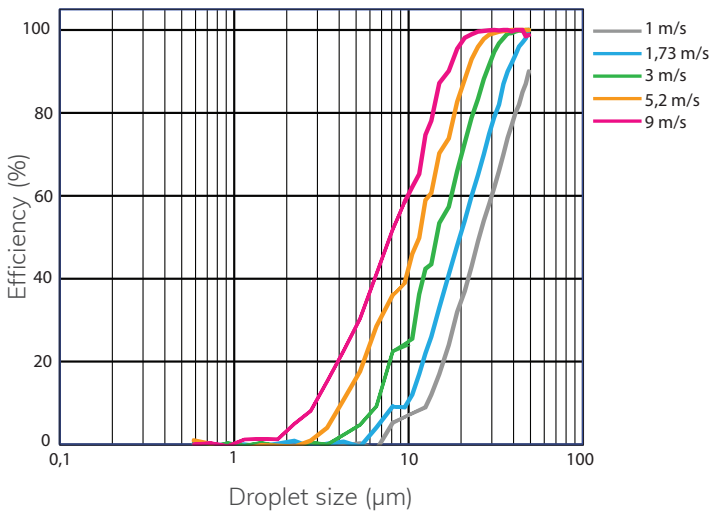

**DSH EFFICIENCY RESULTS**

Two-stage DSH with ePM2,5 65% bag filter

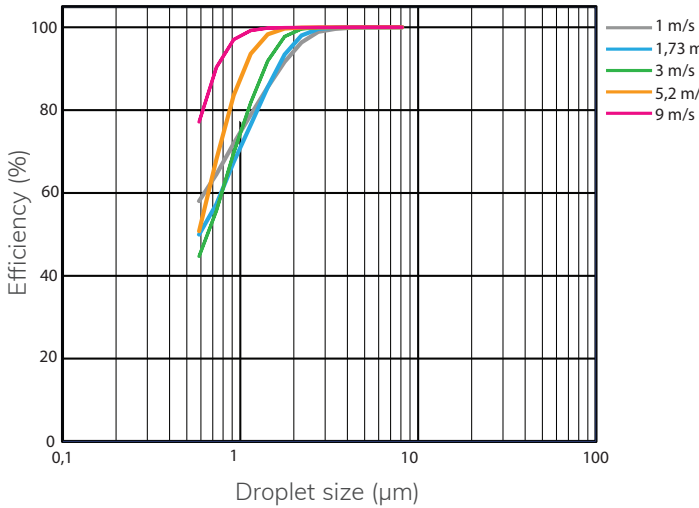

Two-stage DSH with ISO Coarse 70% panel filter (filter depth 48 mm)

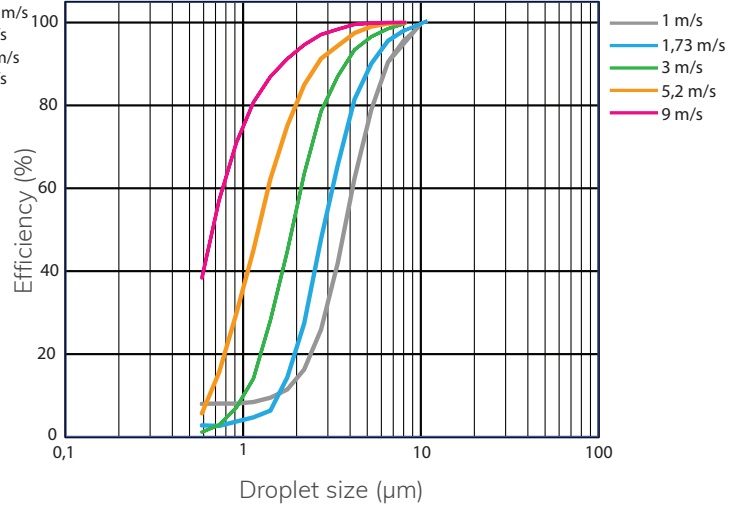

**PERFORMANCE DATA**

- Effectiveness for removal of simulated rain
- EN 13030:2001
- Rainfall rate: 75 (l/h)/m<sup>2</sup>, (75 mm/h)
- Vertical installation

Rainwater effectiveness, material aluminium

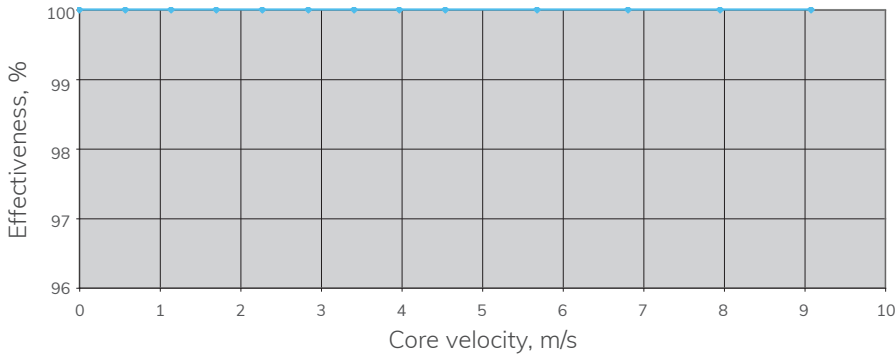

Rainwater effectiveness, material stainless steel

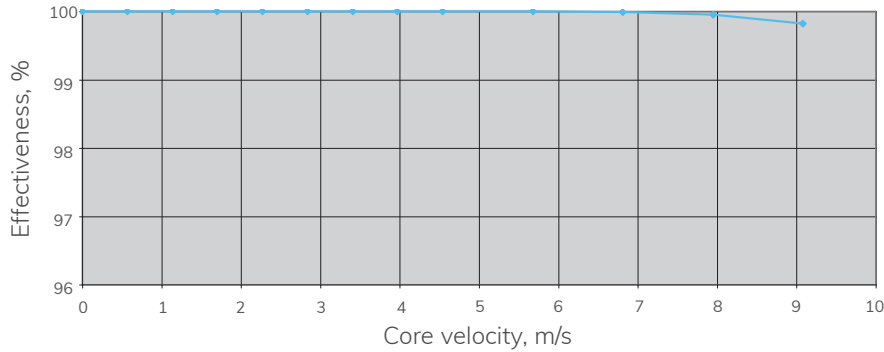

**WEIGHTS****WEIGHTS OF DSH INCLUDING FRAME, ALUMINIUM (KG), PITCH SPACING 28 MM**

H/ HEIGHT (mm)	B / WIDTH (mm)													
	200	300	400	500	600	700	800	900	1000	1100	1200	1300	1400	1500
200	1,7	2,1	3,1	3,9	4,8	5,8	6,7	7,6	8,6	9,4	10,3	11,3	12,2	13,0
300	2,4	2,9	4,4	5,6	6,8	8,3	9,5	10,8	12,2	13,5	14,7	16,2	17,4	18,6
400	3,1	3,7	5,7	7,3	8,9	10,8	12,4	14,0	15,9	17,5	19,1	21,0	22,6	24,2
500	3,9	4,6	7,0	8,9	10,9	13,3	15,2	17,2	19,6	21,5	23,5	25,9	27,8	29,8
600	4,6	5,4	8,3	10,6	12,9	15,8	18,1	20,4	23,3	25,6	27,9	30,8	33,0	35,3
700	5,3	6,3	9,6	12,3	14,9	18,3	20,9	23,6	27,0	29,6	32,2	35,6	38,3	40,9
800	6,0	7,1	10,9	13,9	16,9	20,8	23,8	26,8	30,6	33,6	36,6	40,5	43,5	46,5
900	6,7	7,9	12,3	15,6	19,0	23,3	26,6	30,0	34,3	37,7	41,0	45,4	48,7	52,1
1000	7,5	8,8	13,6	17,3	21,0	25,8	29,5	33,2	38,0	41,7	45,4	50,2	53,9	57,6
1100	8,2	9,6	14,9	19,0	23,0	28,3	32,4	36,4	41,7	45,7	49,8	55,1	59,1	63,2
1200	8,9	10,5	16,2	20,6	25,0	30,8	35,2	39,6	45,4	49,8	54,2	59,9	64,4	68,8

The weights on the table are indicative and do not include the filter.

**WEIGHTS OF DSH INCLUDING FRAME, ALUMINIUM (KG), PITCH SPACING 23 MM**

H/ HEIGHT (mm)	B / WIDTH (mm)													
	200	300	400	500	600	700	800	900	1000	1100	1200	1300	1400	1500
200	2,3	3,3	4,5	5,5	6,5	7,5	8,6	9,6	10,6	11,6	12,8	13,8	14,8	15,8
300	3,4	4,9	6,6	8,1	9,6	11,1	12,8	14,3	15,7	17,2	18,9	20,4	21,9	23,4
400	4,5	6,4	8,8	10,7	12,7	14,6	16,9	18,9	20,8	22,8	25,1	27,1	29,0	31,0
500	5,6	8,0	10,9	13,3	15,8	18,2	21,1	23,5	25,9	28,4	31,3	33,7	36,1	38,6
600	6,6	9,5	13,0	15,9	18,8	21,7	25,2	28,1	31,0	33,9	37,5	40,3	43,2	46,1
700	7,7	11,1	15,2	18,6	21,9	25,3	29,4	32,8	36,1	39,5	43,6	47,0	50,4	53,7
800	8,8	12,6	17,3	21,2	25,0	28,9	33,6	37,4	41,2	45,1	49,8	53,6	57,5	61,3
900	9,9	14,2	19,5	23,8	28,1	32,4	37,7	42,0	46,4	50,7	56,0	60,3	64,6	68,9
1000	10,9	15,7	21,6	26,4	31,2	36,0	41,9	46,7	51,5	56,2	62,1	66,9	71,7	76,5
1100	12,0	17,3	23,8	29,0	34,3	39,6	46,0	51,3	56,6	61,8	68,3	73,6	78,8	84,1
1200	13,1	18,8	25,9	31,6	37,4	43,1	50,2	55,9	61,7	67,4	74,5	80,2	85,9	91,7

The weights on the table are indicative and do not include the filter.

**WEIGHTS OF DSH INCLUDING FRAME, ALUMINIUM (KG), PITCH SPACING 18 MM**

H/ HEIGHT (mm)	B / WIDTH (mm)													
	200	300	400	500	600	700	800	900	1000	1100	1200	1300	1400	1500
200	2,6	3,7	4,9	6,0	7,2	8,3	9,4	10,6	11,7	12,9	14,0	15,1	16,3	17,4
300	3,9	5,7	7,4	9,1	10,8	12,6	14,3	16,0	17,8	19,5	21,2	23,0	24,7	26,4
400	5,2	7,6	9,9	12,2	14,5	16,8	19,2	21,5	23,8	26,1	28,5	30,8	33,1	35,4
500	6,5	9,5	12,4	15,3	18,2	21,1	24,0	27,0	29,9	32,8	35,7	38,6	41,5	44,4
600	7,9	11,4	14,9	18,4	21,9	25,4	28,9	32,4	35,9	39,4	42,9	46,4	49,9	53,4
700	9,2	13,3	17,4	21,5	25,6	29,7	33,8	37,9	42,0	46,1	50,2	54,3	58,4	62,5
800	10,5	15,2	19,9	24,6	29,2	33,9	38,6	43,3	48,0	52,7	57,4	62,1	66,8	71,5
900	11,8	17,1	22,4	27,6	32,9	38,2	43,5	48,8	54,1	59,3	64,6	69,9	75,2	80,5
1000	13,1	19,0	24,9	30,7	36,6	42,5	48,4	54,2	60,1	66,0	71,9	77,7	83,6	89,5
1100	14,4	20,9	27,4	33,8	40,3	46,8	53,2	59,7	66,2	72,6	79,1	85,6	92,0	98,5
1200	15,7	22,8	29,9	36,9	44,0	51,0	58,1	65,1	72,2	79,3	86,3	93,4	100,4	107,5

The weights on the table are indicative and do not include the filter.

**WEIGHTS OF DSH+ML INCLUDING FRAME, ALUMINIUM (KG), PITCH SPACING 28 MM**

H/ HEIGHT (mm)	B / WIDTH (mm)													
	200	300	400	500	600	700	800	900	1000	1100	1200	1300	1400	1500
200	2,8	4,1	5,2	6,3	7,6	8,7	9,9	11,1	12,2	13,4	14,6	15,8	16,9	18,2
300	3,8	5,6	7,2	8,8	10,6	12,1	13,7	15,5	17,1	18,6	20,4	22,0	23,6	25,4
400	4,8	7,2	9,2	11,2	13,5	15,5	17,5	19,9	21,9	23,9	26,2	28,2	30,2	32,6
500	5,9	8,8	11,2	13,6	16,5	19,0	21,4	24,3	26,7	29,1	32,1	34,5	36,9	39,8
600	6,9	10,3	13,2	16,0	19,5	22,4	25,2	28,7	31,5	34,4	37,9	40,7	43,6	47,0
700	7,9	11,9	15,2	18,5	22,5	25,8	29,1	33,1	36,4	39,6	43,7	46,9	50,2	54,2
800	8,9	13,5	17,2	20,9	25,5	29,2	32,9	37,5	41,2	44,9	49,5	53,2	56,9	61,5
900	9,9	15,0	19,2	23,3	28,4	32,6	36,7	41,9	46,0	50,2	55,3	59,4	63,6	68,7
1000	10,9	16,6	21,2	25,8	31,4	36,0	40,6	46,2	50,8	55,4	61,1	65,6	70,2	75,9
1100	12,0	18,2	23,2	28,2	34,4	39,4	44,4	50,6	55,6	60,7	66,9	71,9	76,9	83,1
1200	13,0	19,7	25,2	30,6	37,4	42,8	48,3	55,0	60,5	65,9	72,7	78,1	83,6	90,3

The weights on the table are indicative and do not include the filter.

## WEIGHTS OF DSH+ML INCLUDING FRAME, ALUMINIUM (KG), PITCH SPACING 23 MM

H/ HEIGHT (mm)	B / WIDTH (mm)													
	200	300	400	500	600	700	800	900	1000	1100	1200	1300	1400	1500
200	3,1	4,3	5,7	7,0	8,3	9,5	10,9	12,2	13,5	14,7	16,1	17,4	18,7	19,9
300	4,3	6,1	8,2	10,0	11,8	13,7	15,7	17,5	19,4	21,2	23,2	25,0	26,9	28,7
400	5,6	7,9	10,7	13,0	15,4	17,8	20,5	22,9	25,2	27,6	30,3	32,7	35,1	37,4
500	6,8	9,7	13,2	16,1	19,0	21,9	25,3	28,2	31,1	34,0	37,4	40,4	43,3	46,2
600	8,1	11,6	15,6	19,1	22,6	26,0	30,1	33,6	37,0	40,5	44,5	48,0	51,5	54,9
700	9,3	13,4	18,1	22,1	26,1	30,1	34,9	38,9	42,9	46,9	51,7	55,7	59,7	63,7
800	10,6	15,2	20,6	25,1	29,7	34,3	39,7	44,2	48,8	53,4	58,8	63,3	67,9	72,4
900	11,9	17,0	23,0	28,2	33,3	38,4	44,5	49,6	54,7	59,8	65,9	71,0	76,1	81,2
1000	13,1	18,8	25,5	31,2	36,8	42,5	49,2	54,9	60,6	66,2	73,0	78,6	84,3	90,0
1100	14,4	20,6	28,0	34,2	40,4	46,6	54,0	60,2	66,5	72,7	80,1	86,3	92,5	98,7
1200	15,6	22,4	30,5	37,2	44,0	50,7	58,8	65,6	72,3	79,1	87,2	93,9	100,7	107,5

The weights on the table are indicative and do not include the filter.

## WEIGHTS OF DSH+ML INCLUDING FRAME, ALUMINIUM (KG), PITCH SPACING 18 MM

H/ HEIGHT (mm)	B / WIDTH (mm)													
	200	300	400	500	600	700	800	900	1000	1100	1200	1300	1400	1500
200	3,3	4,7	6,1	7,5	8,9	10,3	11,7	13,1	14,5	15,9	17,3	18,7	20,1	21,5
300	4,8	6,9	9,0	11,0	13,1	15,2	17,2	19,3	21,4	23,4	25,5	27,6	29,7	31,7
400	6,3	9,1	11,8	14,5	17,3	20,0	22,7	25,5	28,2	30,9	33,7	36,4	39,2	41,9
500	7,8	11,2	14,6	18,0	21,4	24,8	28,2	31,6	35,0	38,5	41,9	45,3	48,7	52,1
600	9,3	13,4	17,5	21,5	25,6	29,7	33,7	37,8	41,9	46,0	50,0	54,1	58,2	62,2
700	10,8	15,5	20,3	25,0	29,8	34,5	39,2	44,0	48,7	53,5	58,2	62,9	67,7	72,4
800	12,3	17,7	23,1	28,5	33,9	39,3	44,7	50,1	55,6	61,0	66,4	71,8	77,2	82,6
900	13,8	19,9	25,9	32,0	38,1	44,2	50,2	56,3	62,4	68,5	74,5	80,6	86,7	92,8
1000	15,3	22,0	28,8	35,5	42,3	49,0	55,7	62,5	69,2	76,0	82,7	89,5	96,2	102,9
1100	16,8	24,2	31,6	39,0	46,4	53,8	61,2	68,6	76,1	83,5	90,9	98,3	105,7	113,1
1200	18,3	26,3	34,4	42,5	50,6	58,7	66,7	74,8	82,9	91,0	99,1	107,1	115,2	123,3

The weights on the table are indicative and do not include the filter.

## WEIGHTS OF DSH INCLUDING FRAME, STAINLESS STEEL AISI316 (KG), PITCH SPACING 28 MM

H/ HEIGHT (mm)	B / WIDTH (mm)													
	200	300	400	500	600	700	800	900	1000	1100	1200	1300	1400	1500
200	4,9	6,7	8,6	10,4	12,3	14,1	16,0	17,8	19,7	21,5	23,4	25,2	27,1	28,9
300	6,4	8,5	10,9	13,1	15,5	17,7	20,1	22,2	24,6	26,8	29,2	31,3	33,8	35,9
400	7,9	10,4	13,3	15,8	18,7	21,2	24,1	26,7	29,6	32,1	35,0	37,5	40,4	43,0
500	9,3	12,2	15,6	18,5	21,9	24,8	28,2	31,1	34,5	37,4	40,8	43,7	47,1	50,0
600	10,8	14,1	18,0	21,2	25,1	28,4	32,3	35,6	39,5	42,7	46,6	49,9	53,8	57,1
700	12,3	15,9	20,3	23,9	28,3	32,0	36,4	40,0	44,4	48,1	52,5	56,1	60,5	64,1
800	13,7	17,7	22,6	26,6	31,5	35,6	40,5	44,5	49,4	53,4	58,3	62,3	67,2	71,2
900	15,2	19,6	25,0	29,4	34,8	39,1	44,5	48,9	54,3	58,7	64,1	68,5	73,9	78,3
1000	16,7	21,4	27,3	32,1	38,0	42,7	48,6	53,4	59,3	64,0	69,9	74,7	80,6	85,3
1100	18,1	23,3	29,7	34,8	41,2	46,3	52,7	57,8	64,2	69,3	75,7	80,9	87,2	92,4
1200	19,6	25,1	32,0	37,5	44,4	49,9	56,8	62,3	69,2	74,7	81,5	87,0	93,9	99,4

The weights on the table are indicative and do not include the filter.

## WEIGHTS OF DSH INCLUDING FRAME, STAINLESS STEEL AISI316 (KG), PITCH SPACING 23 MM

H/ HEIGHT (mm)	B / WIDTH (mm)													
	200	300	400	500	600	700	800	900	1000	1100	1200	1300	1400	1500
200	5,1	7,0	9,0	10,9	12,9	14,8	16,8	18,8	20,7	22,6	24,7	26,6	28,5	30,4
300	6,6	9,1	11,7	14,2	16,6	19,0	21,7	24,1	26,5	28,9	31,6	34,0	36,4	38,8
400	8,2	11,2	14,5	17,4	20,3	23,2	26,5	29,4	32,3	35,2	38,5	41,4	44,3	47,3
500	9,8	13,2	17,2	20,6	24,0	27,4	31,3	34,7	38,1	41,5	45,5	48,9	52,3	55,7
600	11,4	15,3	19,9	23,8	27,7	31,6	36,1	40,0	43,9	47,8	52,4	56,3	60,2	64,1
700	13,0	17,4	22,6	27,0	31,4	35,8	41,0	45,4	49,8	54,2	59,3	63,7	68,1	72,5
800	14,6	19,5	25,3	30,2	35,1	40,0	45,8	50,7	55,6	60,5	66,3	71,2	76,1	81,0
900	16,2	21,6	28,0	33,4	38,8	44,2	50,6	56,0	61,4	66,8	73,2	78,6	84,0	89,4
1000	17,8	23,7	30,7	36,6	42,5	48,4	55,4	61,3	67,2	73,1	80,1	86,0	91,9	97,8
1100	19,4	25,8	33,4	39,8	46,2	52,6	60,2	66,6	73,0	79,4	87,1	93,4	99,8	106,2
1200	21,0	27,9	36,1	43,0	49,9	56,8	65,1	72,0	78,8	85,7	94,0	100,9	107,8	114,6

The weights on the table are indicative and do not include the filter.

## WEIGHTS OF DSH INCLUDING FRAME, STAINLESS STEEL AISI316 (KG), PITCH SPACING 18 MM

H/ HEIGHT (mm)	B / WIDTH (mm)													
	200	300	400	500	600	700	800	900	1000	1100	1200	1300	1400	1500
200	5,3	7,5	9,6	11,8	13,9	15,9	18,1	20,2	22,4	24,4	26,5	28,7	30,8	33,0
300	7,2	10,1	12,8	15,8	18,4	21,1	24,1	26,7	29,7	32,4	35,0	38,0	40,7	43,6
400	9,0	12,7	16,0	19,7	23,0	26,3	30,0	33,3	37,0	40,3	43,6	47,3	50,6	54,3
500	10,9	15,3	19,2	23,7	27,6	31,5	35,9	39,9	44,3	48,2	52,1	56,6	60,5	64,9
600	12,7	17,9	22,4	27,6	32,2	36,7	41,9	46,4	51,6	56,1	60,7	65,9	70,4	75,6
700	14,5	20,5	25,6	31,6	36,7	41,9	47,8	53,0	58,9	64,1	69,2	75,2	80,3	86,3
800	16,4	23,1	28,8	35,5	41,3	47,1	53,8	59,5	66,2	72,0	77,8	84,5	90,2	96,9
900	18,2	25,6	32,1	39,5	45,9	52,3	59,7	66,1	73,5	79,9	86,3	93,8	100,2	107,6
1000	20,1	28,2	35,3	43,4	50,4	57,5	65,6	72,7	80,8	87,9	94,9	103,0	110,1	118,2
1100	21,9	30,8	38,5	47,4	55,0	62,7	71,6	79,2	88,1	95,8	103,4	112,3	120,0	128,9
1200	23,8	33,4	41,7	51,3	59,6	67,9	77,5	85,8	95,4	103,7	112,0	121,6	129,9	139,6

The weights on the table are indicative and do not include the filter.

## WEIGHTS OF DSH+ML INCLUDING FRAME, STAINLESS STEEL (KG), PITCH SPACING 28 MM

H/ HEIGHT (mm)	B / WIDTH (mm)													
	200	300	400	500	600	700	800	900	1000	1100	1200	1300	1400	1500
200	7,2	9,8	12,5	15,0	17,7	20,2	22,9	25,5	28,2	30,7	33,4	36,0	38,6	41,2
300	9,1	12,1	15,4	18,4	21,7	24,7	28,0	31,0	34,3	37,3	40,6	43,6	46,9	49,9
400	11,0	14,5	18,4	21,9	25,7	29,2	33,1	36,6	40,5	43,9	47,8	51,3	55,2	58,7
500	12,9	16,9	21,3	25,3	29,8	33,7	38,2	42,1	46,6	50,6	55,0	59,0	63,4	67,4
600	14,8	19,2	24,3	28,7	33,8	38,2	43,3	47,7	52,7	57,2	62,2	66,7	71,7	76,1
700	16,7	21,6	27,3	32,1	37,8	42,7	48,3	53,2	58,9	63,8	69,4	74,3	80,0	84,9
800	18,6	24,0	30,2	35,6	41,8	47,2	53,4	58,8	65,0	70,4	76,6	82,0	88,3	93,6
900	20,5	26,3	33,2	39,0	45,8	51,7	58,5	64,3	71,2	77,0	83,9	89,7	96,5	102,3
1000	22,4	28,7	36,1	42,4	49,9	56,2	63,6	69,9	77,3	83,6	91,1	97,4	104,8	111,1
1100	24,3	31,1	39,1	45,9	53,9	60,7	68,7	75,4	83,5	90,2	98,3	105,0	113,1	119,8
1200	26,2	33,4	42,1	49,3	57,9	65,1	73,8	81,0	89,6	96,9	105,5	112,7	121,3	128,6

The weights on the table are indicative and do not include the filter.

## WEIGHTS OF DSH+ML INCLUDING FRAME, STAINLESS STEEL (KG), PITCH SPACING 23 MM

H/ HEIGHT (mm)	B / WIDTH (mm)													
	200	300	400	500	600	700	800	900	1000	1100	1200	1300	1400	1500
200	7,4	10,0	12,9	15,6	18,3	20,9	23,8	26,5	29,2	31,8	34,7	37,4	40,1	42,7
300	9,4	12,7	16,2	19,5	22,8	26,1	29,6	32,9	36,2	39,5	43,0	46,3	49,6	52,9
400	11,4	15,3	19,5	23,4	27,3	31,2	35,4	39,3	43,2	47,1	51,3	55,2	59,1	63,0
500	13,4	17,9	22,9	27,3	31,8	36,3	41,3	45,7	50,2	54,7	59,7	64,1	68,6	73,1
600	15,4	20,5	26,2	31,3	36,3	41,4	47,1	52,2	57,2	62,3	68,0	73,0	78,1	83,2
700	17,5	23,1	29,5	35,2	40,9	46,5	52,9	58,6	64,2	69,9	76,3	82,0	87,6	93,3
800	19,5	25,7	32,9	39,1	45,4	51,6	58,8	65,0	71,2	77,5	84,6	90,9	97,1	103,4
900	21,5	28,4	36,2	43,0	49,9	56,7	64,6	71,4	78,3	85,1	92,9	99,8	106,6	113,5
1000	23,5	31,0	39,5	47,0	54,4	61,8	70,4	77,8	85,3	92,7	101,3	108,7	116,1	123,6
1100	25,6	33,6	42,9	50,9	58,9	67,0	76,2	84,3	92,3	100,3	109,6	117,6	125,6	133,7
1200	27,6	36,2	46,2	54,8	63,4	72,1	82,1	90,7	99,3	107,9	117,9	126,5	135,2	143,8

The weights on the table are indicative and do not include the filter.

## WEIGHTS OF DSH+ML INCLUDING FRAME, STAINLESS STEEL (KG), PITCH SPACING 18 MM

H/ HEIGHT (mm)	B / WIDTH (mm)													
	200	300	400	500	600	700	800	900	1000	1100	1200	1300	1400	1500
200	7,6	10,6	13,4	16,4	19,2	22,1	25,1	27,9	30,9	33,7	36,5	39,5	42,3	45,3
300	9,9	13,7	17,3	21,1	24,6	28,2	32,0	35,5	39,4	42,9	46,5	50,3	53,8	57,6
400	12,2	16,8	21,1	25,8	30,0	34,3	38,9	43,2	47,9	52,1	56,4	61,1	65,3	70,0
500	14,5	20,0	24,9	30,4	35,4	40,4	45,9	50,9	56,4	61,4	66,3	71,8	76,8	82,3
600	16,7	23,1	28,8	35,1	40,8	46,5	52,8	58,5	64,9	70,6	76,3	82,6	88,3	94,7
700	19,0	26,2	32,6	39,8	46,2	52,6	59,8	66,2	73,4	79,8	86,2	93,4	99,8	107,0
800	21,3	29,3	36,4	44,4	51,6	58,7	66,7	73,9	81,9	89,0	96,2	104,2	111,3	119,3
900	23,5	32,4	40,3	49,1	57,0	64,8	73,7	81,5	90,4	98,2	106,1	115,0	122,8	131,7
1000	25,8	35,5	44,1	53,8	62,4	70,9	80,6	89,2	98,9	107,5	116,0	125,7	134,3	144,0
1100	28,1	38,6	47,9	58,5	67,7	77,0	87,6	96,9	107,4	116,7	126,0	136,5	145,8	156,3
1200	30,4	41,7	51,7	63,1	73,1	83,1	94,5	104,5	115,9	125,9	135,9	147,3	157,3	168,7

The weights on the table are indicative and do not include the filter.

